

安装说明

Phantom Spirit 120 EVO 系列

! 安装前请先去除铜底保护膜

www.thermalright.com

配件清单

AMD AM4/AM5



移除AMD原装塑胶支架, 保留背板, 放置AM4/AM5胶柱, 使用AM4/AM5螺丝将支架固定到主板。



涂好导热膏, 然后用螺丝刀锁好主体, 再用风扇线扣固定风扇

INTEL LGA115X/1200



将背板推到LGA115X卡位, 对应主板孔位穿过主板, 然后从正面扭紧LGA115X螺柱, 放置Intel支架再用螺丝固定住。



涂好导热膏, 然后用螺丝刀锁好主体, 再用风扇线扣固定风扇

INTEL LGA2011/2066



将LGA20XX螺柱拧到主板, 然后放置支架, 再用螺帽固定住INTEL支架。



涂好导热膏, 然后用螺丝刀锁好主体, 再用风扇线扣固定风扇

INTEL LGA1700



将背板推到LGA1700卡位, 对应主板孔位穿过主板, 然后从正面扭紧LGA1700螺柱, 放置Intel支架再用螺丝固定住。



涂好导热膏, 然后用螺丝刀锁好主体, 再用风扇线扣固定风扇

风扇接线



将风扇 4针PWM接头插入主板CPU FAN 插座, 如果使用双风扇, 请使用Y型转接线。

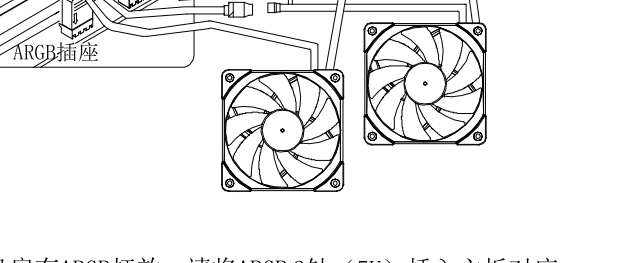

如果风扇有ARGB灯效, 请将ARGB 3针 (5V) 插入主板对应ARGB灯效插座或者控制器, 多风扇之间可串联同步。



INSTALLATION GUIDE

Phantom Spirit 120 EVO Series

Please remove protective sticker before install

www.thermalright.com

parts list

AMD AM4/AM5

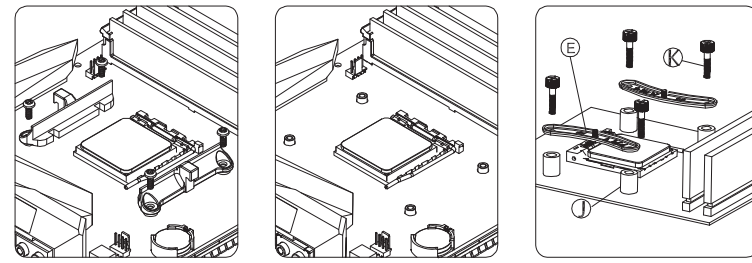

Remove the AMD original plastic support, keep the back plate, and lock it to the original motherboard base plate with AM4/AM5 rubber column

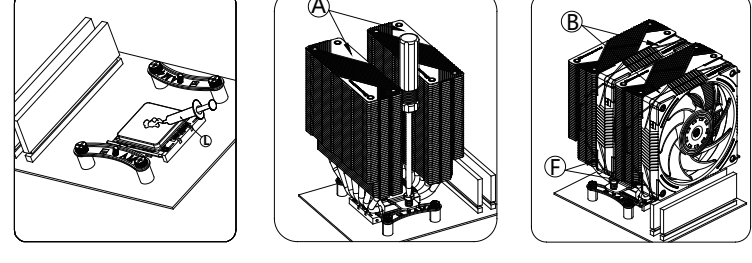

Apply the hot paste, lock the main body with a screwdriver, and fix the fan with a fan wire

INTEL LGA115X/1200

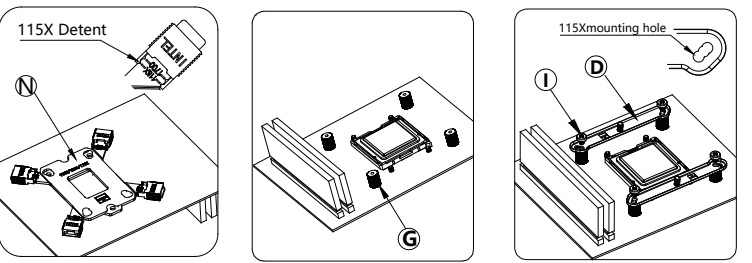

Push the backplane to the LGA115x detent, and the corresponding hole position of the main board passes through the main board, and then tighten the LGA115x stud from the front Place the Intel bracket and fix it with screws

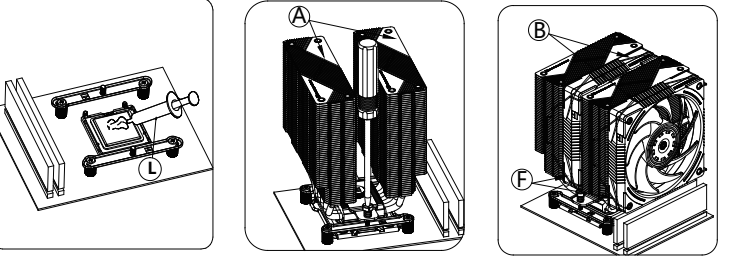

Apply the hot paste, lock the main body with a screwdriver, and fix the fan with a fan wire

INTEL LGA2011/2066

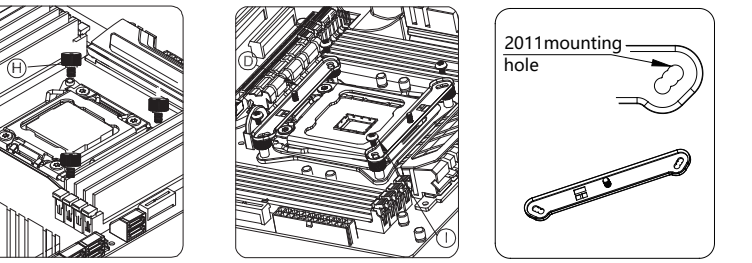

Thread in the LGA20XX screws; put on the brackets and then tightening with nuts.

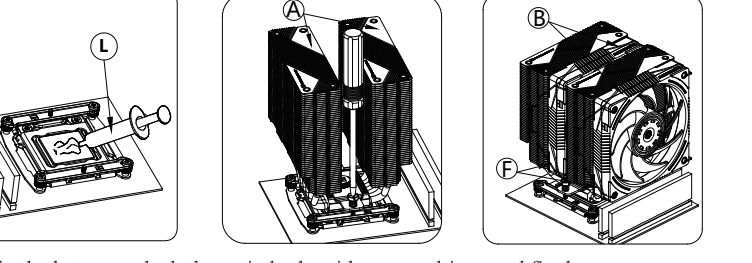

Apply the hot paste, lock the main body with a screwdriver, and fix the fan with a fan wire

INTEL LGA1700

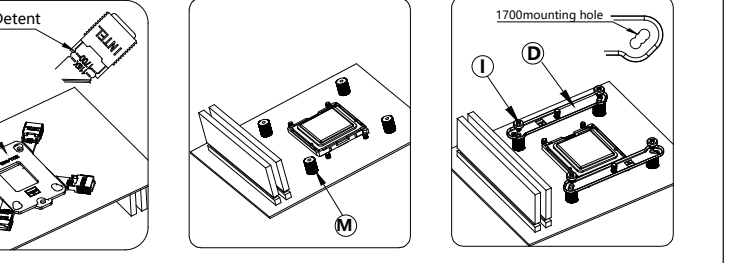

Push the backplane to the LGA1700 detent, and the corresponding hole position of the main board passes through the main board, and then tighten the LGA1700 stud from the front Place the Intel bracket and fix it with screws

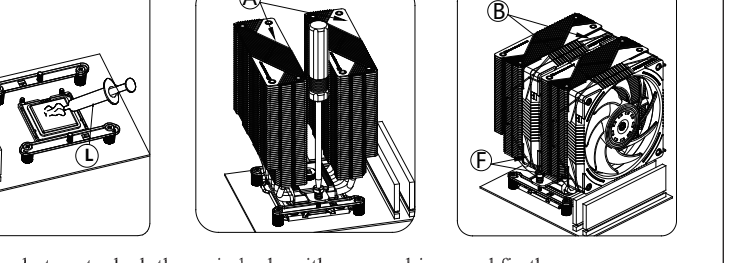

Apply the hot paste, lock the main body with a screwdriver, and fix the fan with a fan wire

Fan Wiring

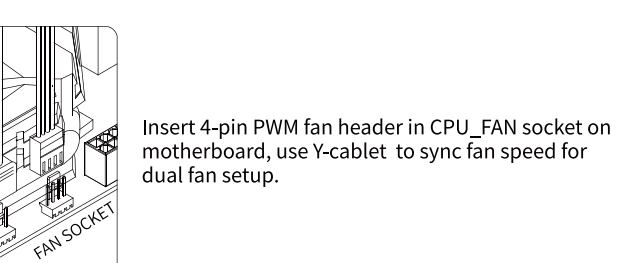

Insert 4-pin PWM fan header in CPU_FAN socket on motherboard, use Y-cable to sync fan speed for dual fan setup.

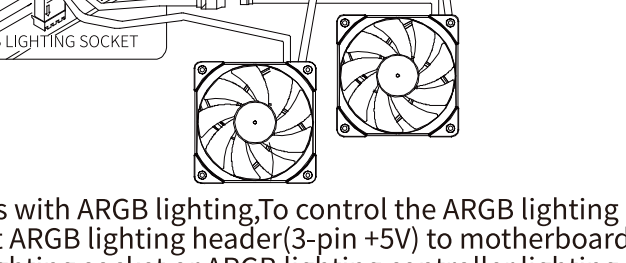

For Fans with ARGB lighting, To control the ARGB lighting, connect ARGB lighting header (3-pin +5V) to motherboard ARGB lighting socket or ARGB lighting controller, lighting effects can be sync by connecting fan lighting headers with each other