

Thermalright

TRUE Spirit 140 Direct

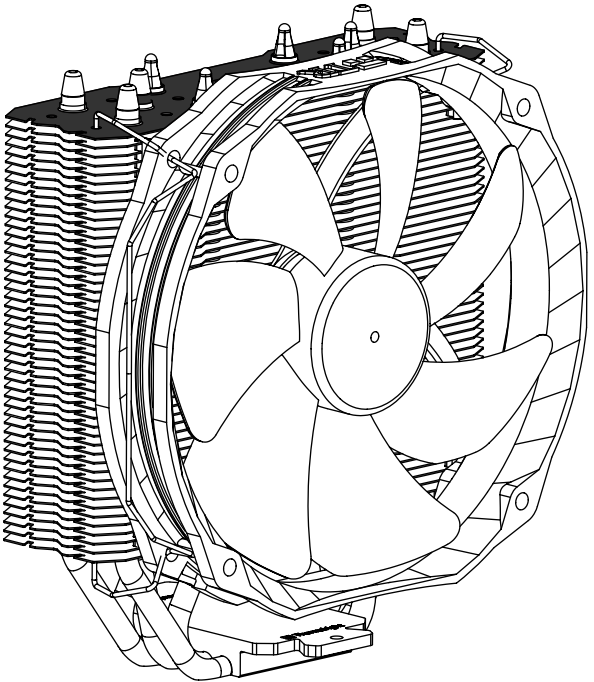

LGA1151 Spacer Installation

- 1.** To use the spacer, install the CPU into socket as instructed by Intel
- 2.** Next, set the Thermalright LGA1151 Spacer on top of the CPU so you can read 'Thermalright' on the hinge side of socket.
- 3.** Close the load plate and secure it with the bolt
- 4.** Job done

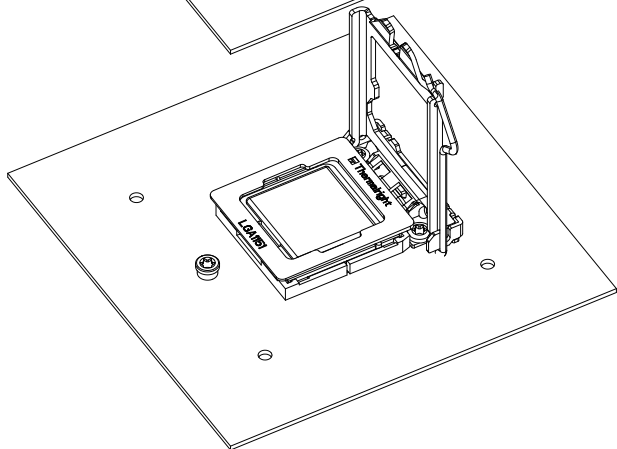
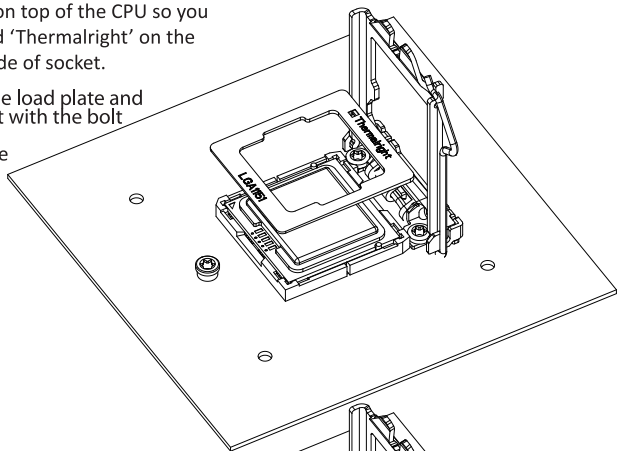

TRUE Spirit 140 Direct

Assembly package



x 4



x 1



x 4



x 8

4



x 5



x 4



x 3



x 4

4



x 5

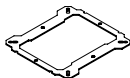

x 1



x 1



x 1



x 4

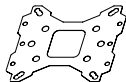

x 1







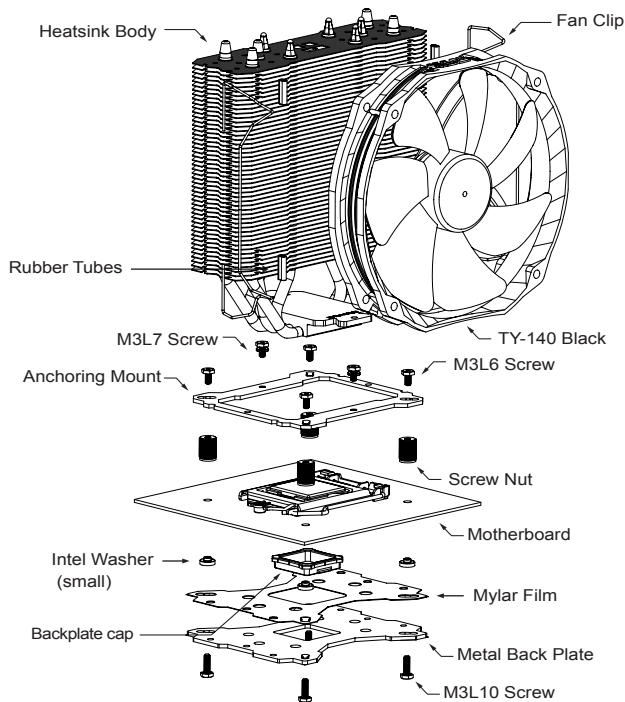



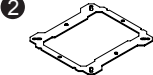



8

Exploded View

Important! Before proceeding with installation, please check for the most up-to-date instructions at www.thermalright.com

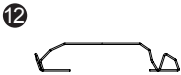

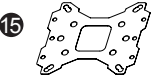
Component

		
		
		
		
		
		
		
1 TS-140 Direct Heatsink Body x1	2 Anchoring Mount x1	3 Metal Back Plate x1
4 Screw Nut x4	5 LGA2011 Type B Screw Pillars x4	6 M3L7 Screw x3
7 M3L10 Screw x5	8 M3 L6 Screw x5	9 Intel Washer (small) x4
10 AMD Washer (big) x4	11 Backplate Cap x1	12 Fan Clip x4
13 Thermal paste x1	14 TY-140 Black x1	15 Mylar Film x1
16 Rubber Tubes x8		

Installation Instructions:

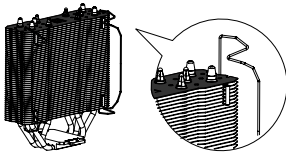
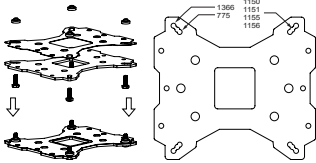
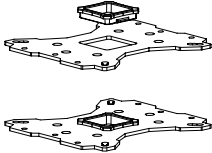
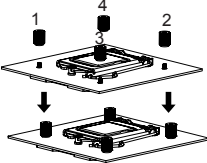
<p>Step 1:</p> 	<p>Step 2:</p> 
<p>Step 1 : Part Installation Take out TS-140 Direct heat-sink from the color box . Pull both ends of the Fan clip and make them go through holes on the corners of the heat-sink. (As shown in the picture.) Repeat for the other fan clip. Leave both fan clips on the heat-sink body for fan installation later on . Insert the four black Rubber Tubes (Noise damping use) into the four indents on the front of the heat-sink body. Do not remove them.</p>	<p>Step 2 : Backplate Installation Choose the platform (775/1150/1151/1155/1156/1366) you are in use. Make four M3L10 Screw Pillars go through the Metal Back Plate and the Mylar film from bottom towards top. And then place the Metal Back Plate on the table. Put the four Washers (for Intel) around the Screw Pillars.</p>
<p>Step 3:</p> 	
<p>Step 3 : 775 Back Plate Cap Note: When installing on a 775 platform, please first insert the Back Plate Cap into the opening on the Back plate, make sure you have the Cap facing downwards. (Only for LGA775 platform, all other platforms go directly to Step 4.).</p>	
<p>Step 4:</p> 	
<p>Step 4 : Screw Cylinder Installation Place the motherboard on top of the Back Plate. See the four Screw Pillars go through the four holes around the processor socket. Cap the four Screw Pillars with the four Screw Nuts. Make sure the side with a washer is facing the Back Plate.</p>	

Step 5:

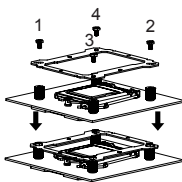

Step 5 : Anchoring Mount Installation
Place the Anchoring Mount on the Screw Nuts. Use the four M3L6 Screws to fix the Anchoring Mount on to the Screw Nuts.

Step 6:

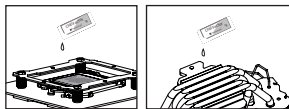

Step 6 : Apply the Thermal Paste
Apply the Thermal Paste to the base of the heat-sink and the surface of the CPU evenly. (A flat edge, like a business card or an old credit card would be beneficial in spreading the Thermal Paste.)

Step 7:

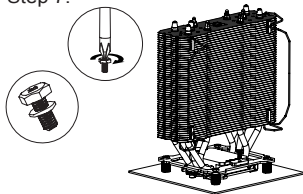

Step 7: Easy Access
Place the Heatsink Body on top of the CPU. And then use the two M3L7 Screws to secure the Anchoring Mount"

Step 8:

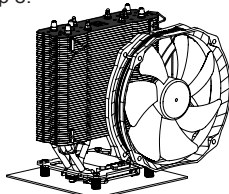

Step 8: Fan Installation
Place the included TY-140 Black onto the Heatsink Body. And then secure it with the Fan Clips, by pulling the Fan Clips to place the four ends at the four holes on the TY-140 Black.

Step 9:

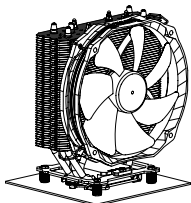







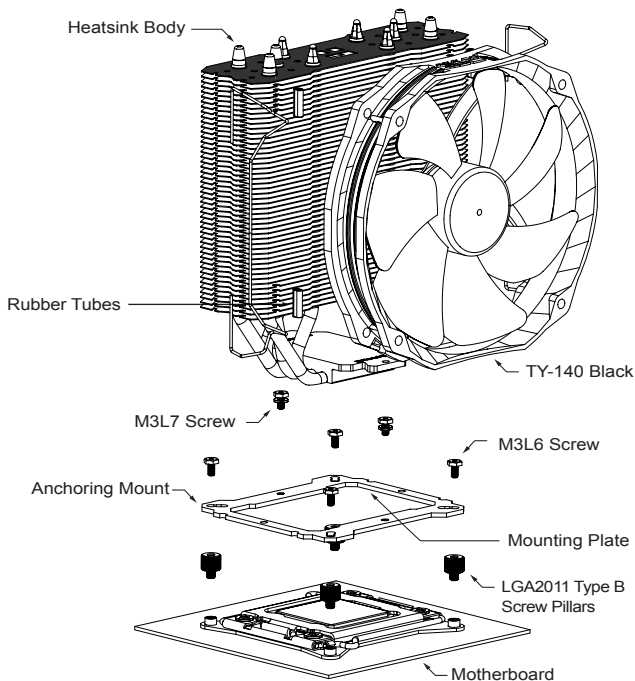



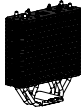
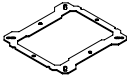
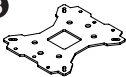



Step 9: Installation completed
Plug in the fan connector to the CPU PWM Fan socket on the motherboard. Installation complete.

Exploded View

Important! Before proceeding with installation, please check for the most up-to-date instructions at www.thermalright.com

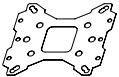

Component

  		
		
		
		
		
		
		
1 TS-140 Direct Heatsink Body ×1	2 Anchoring Mount ×1	3 Metal Back Plate ×1
4 Screw Nut ×4	5 LGA2011 Type B Screw Pillars ×4	6 M3L7 Screw ×3
7 M3L10 Screw ×5	8 M3 L6 Screw ×5	9 Intel Washer (small) ×4
10 AMD Washer (big) ×4	11 Backplate Cap ×1	12 Fan Clip ×4
13 Thermal paste ×1	14 TY-140 Black ×1	15 Mylar Film ×1
16 Rubber Tubes ×8		

Installation Instructions:

Step 1:

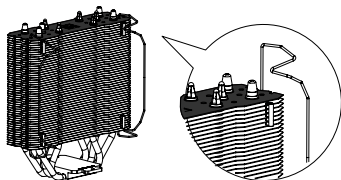

Step 1 : Screw Pillar Installation

Take out TS-140 Direct heat-sink from the color box . Pull both ends of the Fan clip and make them go through holes on the corners of the heat-sink. (As shown in the picture.) Repeat for the other fan clip. Leave both fan clips on the heat-sink body for fan installation later on . Insert the four black Rubber Tubes (Noise damping use) into the four indents on the front of the heat-sink body. Do not remove them.

Step 2:

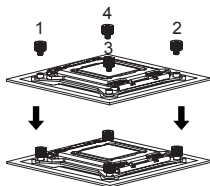

Step 2 : Screw Pillar Installation

Place the motherboard (the processor installed) on top of the desk or a workbench. Fix the four included LGA2011 Type B Screw Pillars into the heat-sink studs on the Intel ILM Assembly Frame around the processor socket in a criss-cross pattern.

Step 3:

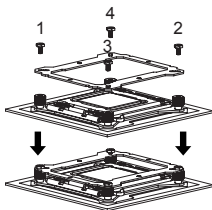

Step 3 : Anchoring Mount Installation

Place the Anchoring Mount on the Screw Pillars. Use the four M3L6 Screws to fix the Anchoring Mount on to the Screw Pillars, also in a criss-cross pattern to ensure balanced mounting.

Step 4:

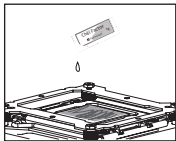

Step 4 : Apply the Thermal Paste

Apply the Thermal Paste to the base of the heat-sink and the surface of the CPU evenly. (A flat edge, like a business card or an old credit card would be beneficial in spreading the Thermal Paste.)

Step 5:

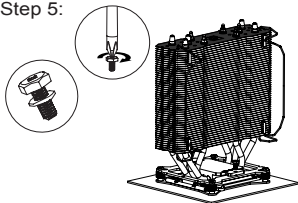

Step 6:

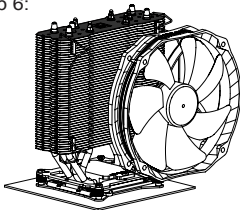

Step 5 : Easy Access

Place the Heatsink Body on top of the CPU. And then use the two M3L7 Screws to secure the Anchoring Mount"

Step 6 : Fan Installation

Place the included TY-140 Black onto the Heatsink Body. And then secure it with the Fan Clips, by pulling the Fan Clips to place the four ends at the four holes on the TY-140 Black.

Step 7:

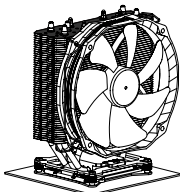

Step 7 : Installation completed







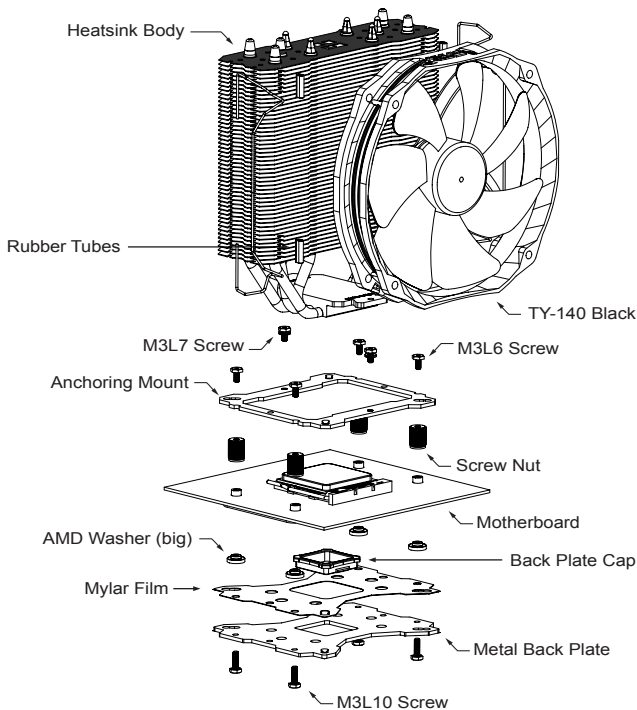



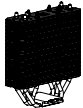
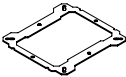



Plug in the fan connector to the CPU PWM Fan socket on the motherboard. Installation complete.

Exploded View

Important! Before proceeding with installation, please check for the most up-to-date instructions at www.thermalright.com

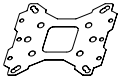

Component

  		
		
		
		
		
		
		
1 TS-140 Direct Heatsink Body ×1	2 Anchoring Mount ×1	3 Metal Back Plate ×1
4 Screw Nut ×4	5 LGA2011 Type B Screw Pillars ×4	6 M3L7 Screw ×3
7 M3L10 Screw ×5	8 M3 L6 Screw ×5	9 Intel Washer (small) ×4
10 AMD Washer (big) ×4	11 Backplate Cap ×1	12 Fan Clip ×4
13 Thermal paste ×1	14 TY-140 Black ×1	15 Mylar Film ×1
16 Rubber Tubes ×8		

Installation Instructions:

Step 1:

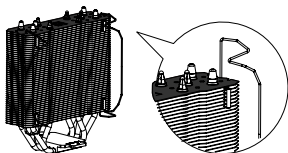

Step 1 : Part Installation

Take out TS-140 Direct heat-sink from the color box . Pull both ends of the Fan clip and make them go through holes on the corners of the heat-sink. (As shown in the picture.) Repeat for the other fan clip. Leave both fan clips on the heat-sink body for fan installation later on . Insert the four black Rubber Tubes (Noise damping use) into the four indents on the front of the heat-sink body. Do not remove them.

Step 2:

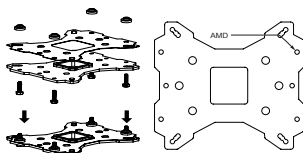

Step 2 : Backplate Installation

Choose the platform (AMD) you are in use. Make four M3L10 Screw Pillars go through the Metal Back Plate and the Mylar film from bottom towards top. And then place the Metal Back Plate on the table. Put the four Washers (for AMD) around the Screw Pillars.

Step 3:

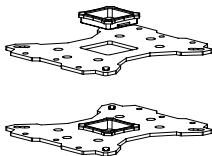

Step 3 : Back Plate Cap

Note: When installing on an AMD platform, please first insert the Back Plate Cap into the opening on the Metal Back plate, make sure you have the Cap facing downwards.

Step 4:

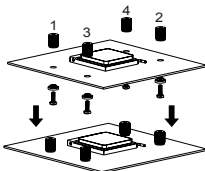

Step 4 : Screw Cylinder Installation

Place the motherboard on top of the Back Plate. See the four Screw Pillars go through the four holes around the processor socket. Cap the four Screw Pillars with the four Screw Nuts. Make sure the side with a washer is facing the Back Plate.

Step 5:

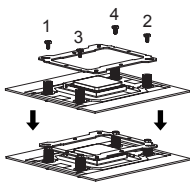

Step 5 : Anchoring Mount Installation
Place the Anchoring Mount on the Screw Nuts. Use the four M3L6 Screws to fix the Anchoring Mount on to the Screw Nuts.

Step 6:

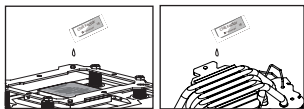

Step 6 : Apply the Thermal Paste
Apply the Thermal Paste to the base of the heat-sink and the surface of the CPU evenly. (A flat edge, like a business card or an old credit card would be beneficial in spreading the Thermal Paste.)

Step 7:

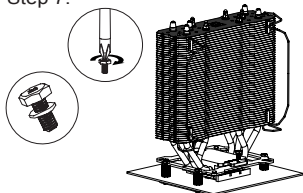

Step 7: Easy Access
Place the Heatsink Body on top of the CPU. And then use the two M3L7 Screws to secure the Anchoring Mount"

Step 8:

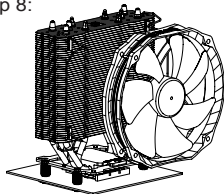

Step 8: Fan Installation
Place the included TY-140 Black onto the Heatsink Body. And then secure it with the Fan Clips, by pulling the Fan Clips to place the four ends at the four holes on the TY-140 Black.

Step 9:

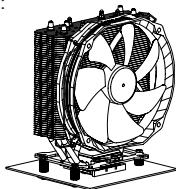







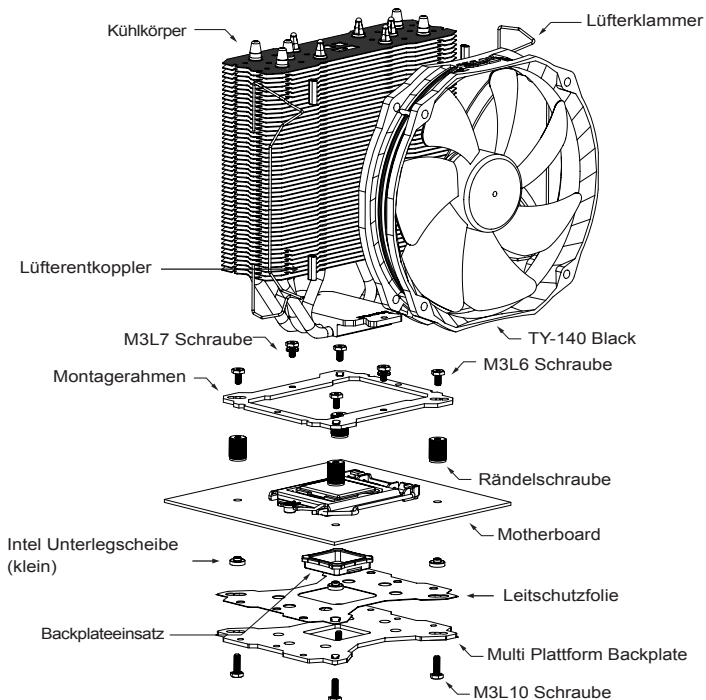



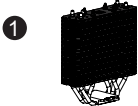
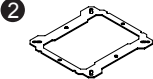



Step 9: Installation completed
Plug in the fan connector to the CPU PWM Fan socket on the motherboard. Installation complete.

Explosionszeichnung

Wichtig! Bitte prüfen Sie vor der Montage, ob für Ihren Kühler aktualisierte Montagehinweise auf der Webseite: www.thermalright.com verfügbar sind.

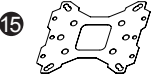

Komponenten

		
		
		
		
		
		
		
1 TS-140 Direct Kühlkörper x1	2 Montagerahmen x1	3 Mult Plattform Backplate x1
4 Rändelschrauben x4	5 LGA2011 Type B Adapterschrauben x4	6 M3L7 Schraube x3
7 M3L10 Schraube x5	8 M3 L6 Schraube x5	9 Intel Unterlegscheibe (klein) x4
10 AMD Unterlegscheibe (groß) x4	11 Backplateeinsatz x1	12 Lüfterklammer x4
13 Wärmeleitpaste x1	14 TY-140 Black x1	15 Schraubendreher x1
16 Lüfterentkoppler x8		

Installationsanleitung:

Schritt 1:

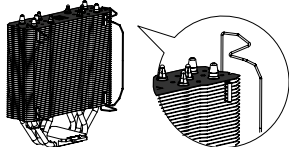

Nehmen Sie den TS-140 Direct aus dem Karton. Haken Sie beide Enden der Lüfterklammern in den Löchern an den Ecken ein, wie auf dem Bild zu sehen. Belassen Sie die Lüfterklammern für die spätere Lüfterinstallation an dem Kühlkörper. Bringen Sie die vier Lüfterentkoppler in den vorgesehenen Vertiefungen auf der Vorderseite des Kühlkörpers an.

Schritt 2:

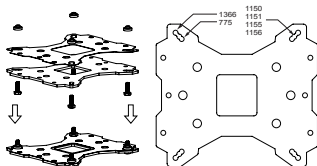

Achten Sie auf die entsprechenden Intel Socket (775/1150/1151/1155/1156/1366) vorgesehene Bohrungen in der Multi Plattform Backplate. Führen Sie die M3L10 Schrauben jeweils von unten durch die Backplate und die mitgelieferte Leitschutzfolie und legen dann die Backplate auf den Tisch. Legen Sie die vier Unterlegscheiben (für Intel) über die hervorstehenden Gewinde.

Schritt 3:

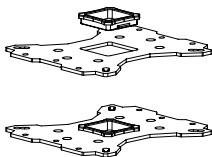

Beachten Sie:

Bei Verwendung einer Intel Socket 775 Plattform setzen Sie zuerst den Backplateeinsatz in die quadratische Öffnung der Backplate ein. Gehen Sie sicher das der Aufsatz nach unten zeigt. (Nur für LGA775 Plattformen)

Schritt 4:

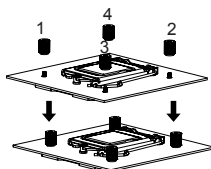

Platzieren Sie das Mainboard von oben auf die Backplate, so dass die hervorstehenden Schraubgewinde durch die Löcher um den Prozessorsocket gehen. Schrauben Sie die vier beiliegenden Rändelschrauben auf die vier Schraubengewinde. Achten Sie dabei darauf, dass die Seite mit der Unterlegscheibe zur Backplate zeigt.

Schritt 5:

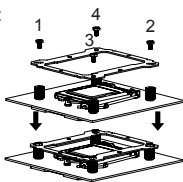

Setzen Sie den Montagerahmen auf die vier Rändelschrauben. Verwenden Sie die vier M3L6 Schrauben, um den Montagerahmen auf den Rändelschrauben zu befestigen.

Schritt 6:

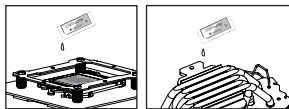

Tragen Sie eine hauchdünne Schicht Wärmeleitpaste auf der Oberfläche der CPU und auf der Unterseite des Kühlers auf.

Schritt 7:

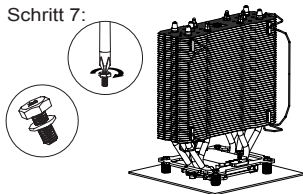

Platzieren Sie den Kühlkörper auf der CPU. Nutzen Sie die zwei M3L7 Schrauben um den Montagerahmen zu sichern.

Schritt 8:

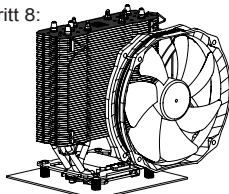

Platzieren Sie den mitgelieferten Lüfter am Kühlkörper und sichern ihn mit den Lüfterklammern. Hierzu ziehen Sie an den am Kühlkörper befestigten Klammern, um die Ecken in die Befestigungslöcher im Lüfterrahmen einrasten zu lassen.

Schritt 9:

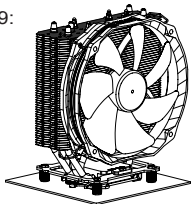







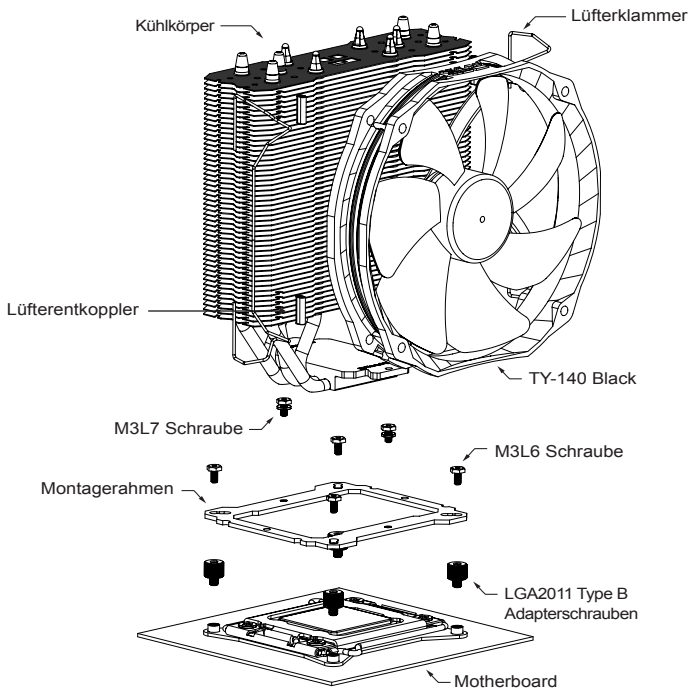



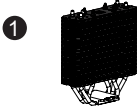
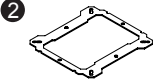



Schließen Sie den Lüfterstecker an den CPU PWM Lüfteranschluss auf dem Mainboard an. Bitte prüfen Sie die ordnungsgemäße Funktion vor der Inbetriebnahme Ihres PC. Die Installation ist abgeschlossen.

Explosionszeichnung

Wichtig! Bitte prüfen Sie vor der Montage, ob für Ihren Kühler aktualisierte Montagehinweise auf der Webseite: www.thermalright.com verfügbar sind.

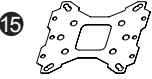

Komponenten

		
		
		
		
		
		
		
1 TS-140 Direct Kühlkörper x1	2 Montagerahmen x1	3 Mult Plattform Backplate x1
4 Rändelschrauben x4	5 LGA2011 Type B Adapterschrauben x4	6 M3L7 Schraube x3
7 M3L10 Schraube x5	8 M3 L6 Schraube x5	9 Intel Unterlegscheibe (klein) x4
10 AMD Unterlegscheibe (groß) x4	11 Backplateeinsatz x1	12 Lüfterklammer x4
13 Wärmeleitpaste x1	14 TY-140 Black x1	15 Schraubendreher x1
16 Lüfterentkoppler x8		

Installationsanleitung:

Schritt 1:

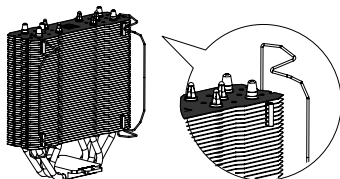

Nehmen Sie den TS-140 Direct aus dem Karton. Haken Sie beide Enden der Lüfterklammern in den Löchern an den Ecken ein, wie auf dem Bild zusehen. Belassen Sie die Lüfterklammern jedoch am Kühlkörper. Bringen Sie die vier Lüfterentkoppler in den vorgesehenen Vertiefungen auf der Vorderseite des Kühlkörpers an.

Schritt 2:

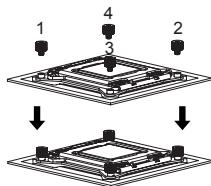

Platzieren Sie das Mainboard auf eine feste Unterlage, z.B. einen Schreibtisch. Befestigen Sie die vier mitgelieferten LGA2011 Type B Adapterschrauben in den dafür vorgesehenen Halterungen des Intel ILM Einbaurahmens.

Schritt 3:

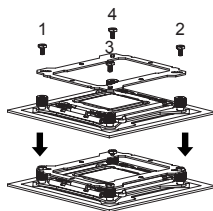

Setzen Sie den Montagerahmen auf die Rändelschrauben. Verwenden Sie die vier M3L6 Schrauben, um den Montagerahmen auf den Rändelschrauben zu befestigen.

Schritt 4:

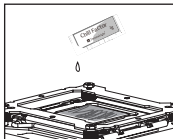

Tragen Sie eine hauchdünne Schicht Wärmeleitpaste auf der Oberfläche der CPU und auf der Unterseite des Kühlers auf.

Schritt 5:

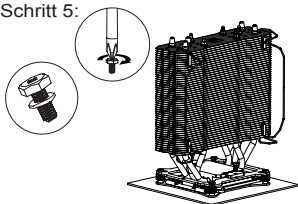

Platzieren Sie den Kühlkörper auf der CPU. Nutzen Sie die zwei M3L7 Schrauben um den Montagerahmen zu sichern.

Schritt 6:

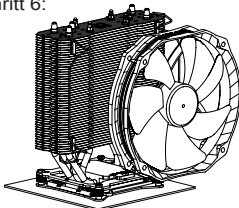

Platzieren Sie den mitgelieferten Lüfter am Kühlkörper und sichern ihn mit den Lüfterklammern. Hierzu ziehen Sie an den am Kühlkörper befestigten Klammern, um die Ecken in die Befestigungslöcher im Lüfterrahmen einrasten zu lassen.

Schritt 7:

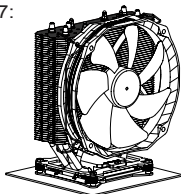







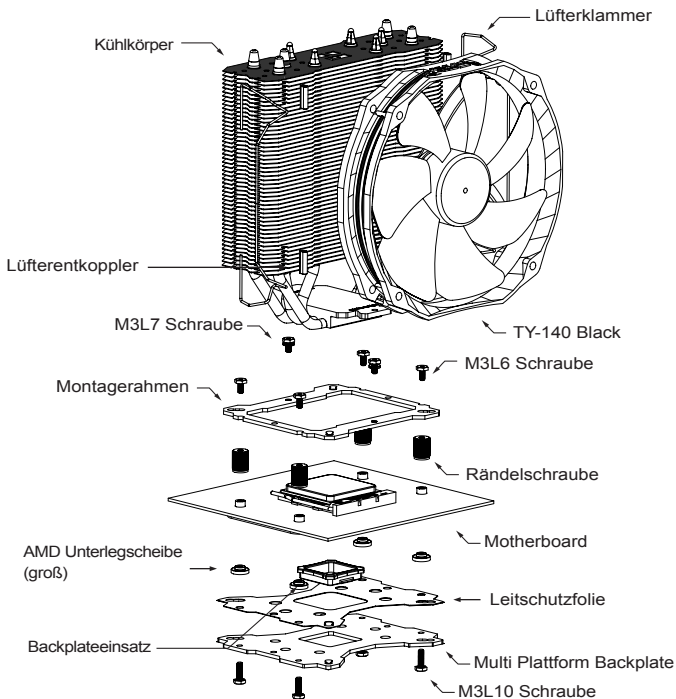



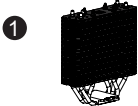
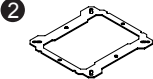



Schließen Sie den Lüfterstecker an den CPU PWM Lüfteranschluss auf dem Mainboard an. Bitte prüfen Sie die ordnungsgemäße Funktion vor der Inbetriebnahme Ihres PC. Die Installation ist abgeschlossen.

Explosionszeichnung

Wichtig! Bitte prüfen Sie vor der Montage, ob für Ihren Kühler aktualisierte Montagehinweise auf der Webseite: www.thermalright.com verfügbar sind.

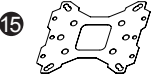

Komponenten

		
		
		
		
		
		
		
1 TS-140 Direct Kühlkörper x1	2 Montagerahmen x1	3 Mult Plattform Backplate x1
4 Rändelschrauben x4	5 LGA2011 Type B Adapterschrauben x4	6 M3L7 Schraube x3
7 M3L10 Schraube x5	8 M3 L6 Schraube x5	9 Intel Unterlegscheibe (klein) x4
10 AMD Unterlegscheibe (groß) x4	11 Backplateeinsatz x1	12 Lüfterklammer x4
13 Wärmeleitpaste x1	14 TY-140 Black x1	15 Schraubendreher x1
16 Lüfterentkoppler x8		

Installationsanleitung:

Schritt 1:

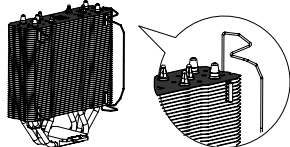

Nehmen Sie den TS-140 Direct aus dem Karton. Haken Sie beide Enden der Lüfterklammern in den Löchern an den Ecken ein, wie auf dem Bild zusehen. Belassen Sie die Lüfterklammern jedoch am Kühlkörper. Bringen Sie die vier Lüfterentkoppler in den vorgesehenen Vertiefungen auf der Vorderseite des Kühlkörpers an.

Schritt 2:

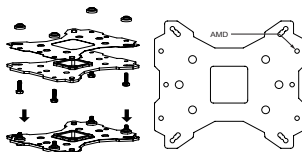

Achten Sie auf die für den AMD Sockel vorgesehene Bohrungen in der Multi Plattform Backplate. Führen Sie die vier M3L10 Schrauben jeweils von unten durch die Backplate und die mitgelieferte Leitschutzfolie und legen dann die Backplate auf den Tisch. Legen Sie die vier Unterlegscheiben (für AMD) über die hervorstehenden Gewinde.

Schritt 3:

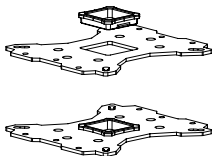

Bei Verwendung einer AMD Sockel 939 Plattform setzen Sie zuerst den Backplateeinsatz in die quadratische Öffnung der Backplate ein. Gehen Sie sicher, dass der Aufsatz nach unten zeigt.

Schritt 4:

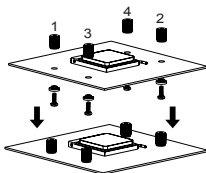

Platzieren Sie das Mainboard von oben auf die Backplate, so dass die hervorstehenden Schraubengewinde durch die Löcher um den Prozessorsockel gehen. Schrauben Sie die vier beiliegenden Rändelschrauben auf die vier Schraubengewinde. Achten Sie dabei darauf, dass die Seite mit der Unterlegscheibe zur Backplate zeigt.

Schritt 5:

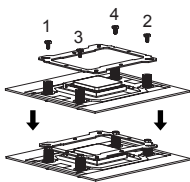

Setzen Sie den Montagerahmen auf die Rändelschrauben. Verwenden Sie die vier M3L6 Schrauben, um den Montagerahmen auf den Rändelschrauben zu befestigen

Schritt 6:

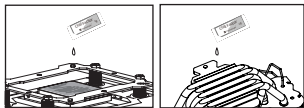

Tragen Sie eine hauchdünne Schicht Wärmeleitpaste auf der Oberfläche der CPU und auf der Unterseite des Kühlers auf.

Schritt 7:

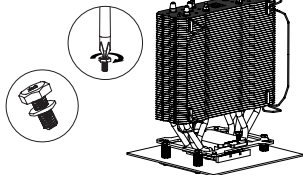

Platzieren Sie den Kühlkörper auf der CPU. Nutzen Sie die zwei M3L7 Schrauben um den Montagerahmen zu sichern.

Schritt 8:

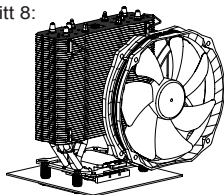

Platzieren Sie den mitgelieferten Lüfter am Kühlkörper und sichern ihn mit den Lüfterklammern. Hierzu ziehen Sie an den am Kühlkörper befestigten Klammern, um die Ecken in die Befestigungslöcher im Lüfterrahmen einrasten zu lassen.

Schritt 9:

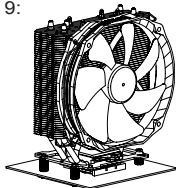







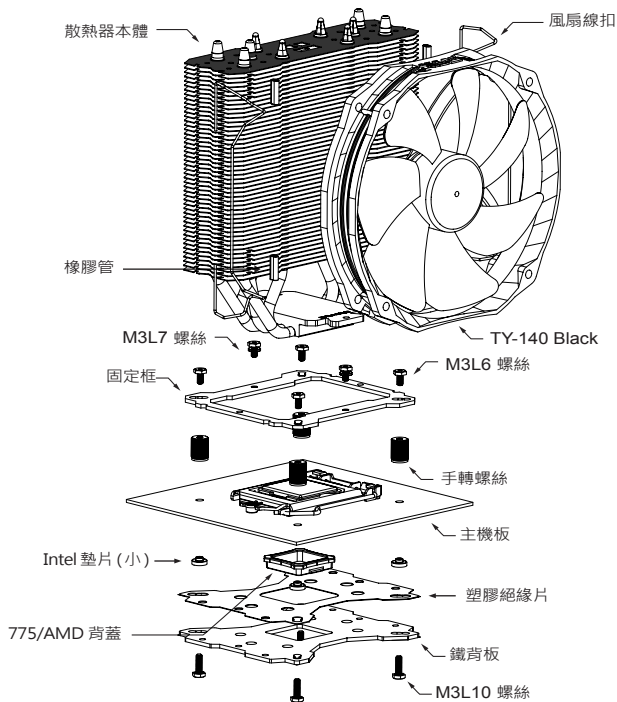



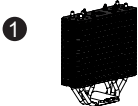
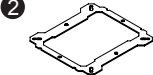



Schließen Sie den Lüfterstecker an den CPU PWM Lüfteranschluss auf dem Mainboard an. Bitte prüfen Sie die ordnungsgemäße Funktion vor der Inbetriebnahme Ihres PC. Die Installation ist abgeschlossen.

分解圖

注意！在您安裝前請先至官網首頁查看是否有更新版安裝指南
www.thermalright.com

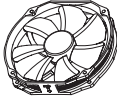
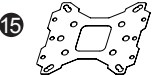

分裝圖

		
		
		
		
		
		
		
1 TS-140 Direct 散熱器本體 ×1	2 固定框 ×1	3 鐵背板 ×1
4 手轉螺絲 ×4	5 LGA2011 Type B 手轉螺絲 ×4	6 M3L7 螺絲 ×3
7 M3L10 螺絲 ×5	8 M3 L6 螺絲 ×5	9 Intel 墊片 (小) ×4
10 AMD 墊片 (大) ×4	11 775/AMD 背蓋 ×1	12 風扇線扣 ×4
13 導熱膏 ×1	14 TY-140 Black ×1	15 塑膠絕緣片 ×1
16 橡膠管 ×8		

安裝指南：

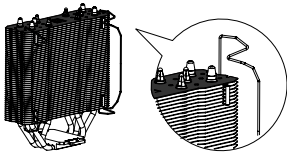
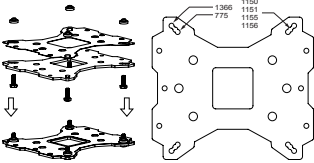
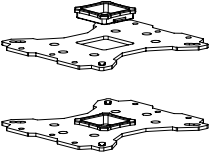
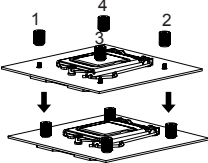
<p>步驟一：</p> 	<p>步驟二：</p> 
<p>步驟一： 先將風扇線扣裝置於散熱器本體，再將四個黑色砂膠管放入鰭片的四個凹痕。</p>	<p>步驟二： 依照您的處理器類型 (775/1150/1151/1155/1156/1366) 選擇對應於背板的孔位，將四根 M3L10 螺絲穿過背板及塑膠絕緣片後套上 Intel 墊圈 (小)。</p>
<p>步驟三：</p> 	
<p>步驟三： 注意！當您安裝於 775 主機板時，請先將 775 背蓋安裝於背板上。</p>	
<p>步驟四：</p> 	
<p>步驟四： 將背板安裝於主機板背面，再依序將穿過主機板的四個螺絲套上手轉螺絲。</p>	

步驟五：

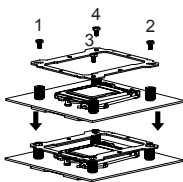

步驟六：

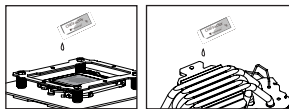

步驟五：

將固定框置於手轉螺絲上，再將 M3L6 螺絲穿過固定框，依序鎖入手轉螺絲上。

步驟六：

塗抹導熱膏於散熱器熱導管及中央處理器銅蓋上。

步驟七：

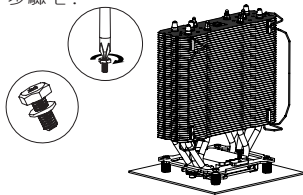

步驟八：

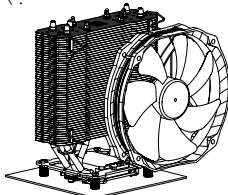

步驟七

將散熱器置放於中央處理器上，再用 M3L7 螺絲穿過散熱器底部兩邊的螺絲孔位，鎖入固定框的對應孔位。

步驟八：

將風扇平貼於散熱器上，並將風扇線扣置風扇螺絲固定孔。

步驟九：

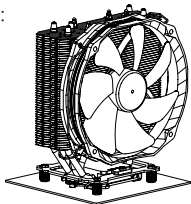

步驟九：







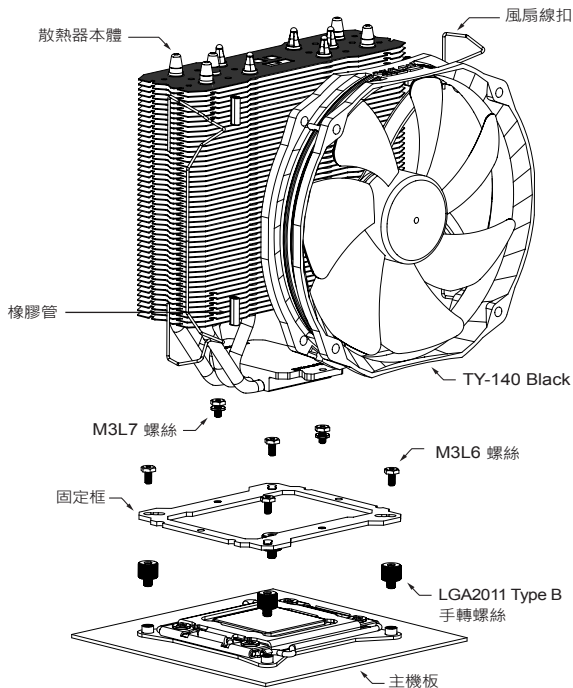



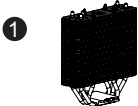
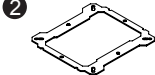



最後將風扇接頭插入主機板上的 CPU FAN 插槽，安裝完成。

分解圖

注意！在您安裝前請先至官網首頁查看是否有更新版安裝指南
www.thermalright.com

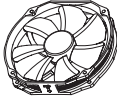

分裝圖

		
		
		
		
		
		
		
1 TS-140 Direct 散熱器本體 ×1	2 固定框 ×1	3 鐵背板 ×1
4 手轉螺絲 ×4	5 LGA2011 Type B 手轉螺絲 ×4	6 M3L7 螺絲 ×3
7 M3L10 螺絲 ×5	8 M3 L6 螺絲 ×5	9 Intel 墊片 (小) ×4
10 AMD 墊片 (大) ×4	11 775/AMD 背蓋 ×1	12 風扇線扣 ×4
13 導熱膏 ×1	14 TY-140 Black ×1	15 塑膠絕緣片 ×1
16 橡膠管 ×8		

安裝指南：

步驟一：

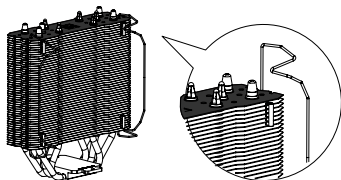

步驟一：

先將風扇線扣裝置於散熱器本體，再將四個黑色矽膠管放入鱗片的四個凹痕。

步驟二：

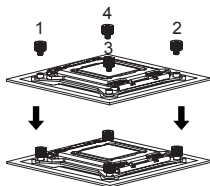

步驟二：

將 LGA2011 手轉螺絲依序轉上中央處理器周圍的四個螺絲孔位。

步驟三：

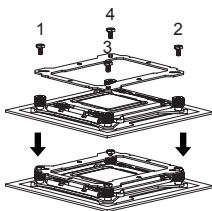

步驟三：

將固定框置於手轉螺絲上，再將 M3L6 螺絲穿過固定框，依序鎖入手轉螺絲上。

步驟四：

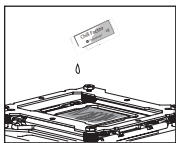

步驟四：
塗抹導熱膏於散熱器熱導管及中央處理器銅蓋上。

步驟五：

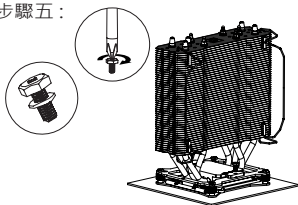

步驟六：

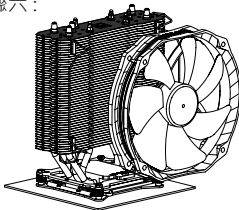

步驟五：
將散熱器置放於中央處理器上，再用 M3L7 螺絲穿過散熱器底部兩邊的螺絲孔位，鎖入固定框的對應孔位。

步驟六：
將風扇平貼於散熱器上，並將風扇線扣置風扇螺絲固定孔。

步驟七：

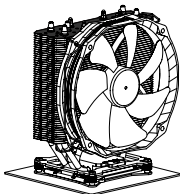







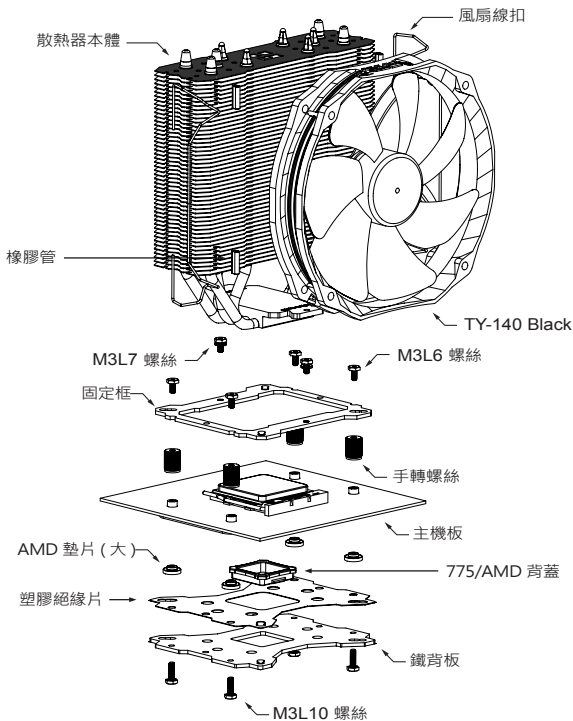



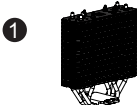
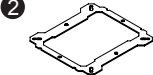



步驟七：
最後將風扇接頭插入主機板上的 CPU FAN 插槽，安裝完成。

分解圖

注意！在您安裝前請先至官網首頁查看是否有更新版安裝指南
www.thermalright.com

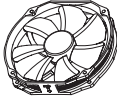
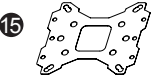

分裝圖

		
		
		
		
		
		
		
1 TS-140 Direct 散熱器本體 ×1	2 固定框 ×1	3 鐵背板 ×1
4 手轉螺絲 ×4	5 LGA2011 Type B 手轉螺絲 ×4	6 M3L7 螺絲 ×3
7 M3L10 螺絲 ×5	8 M3 L6 螺絲 ×5	9 Intel 墊片 (小) ×4
10 AMD 墊片 (大) ×4	11 775/AMD 背蓋 ×1	12 風扇線扣 ×4
13 導熱膏 ×1	14 TY-140 Black ×1	15 塑膠絕緣片 ×1
16 橡膠管 ×8		

安裝指南：

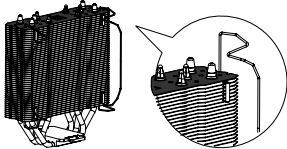
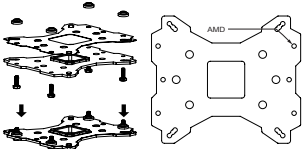
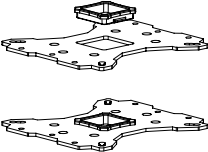
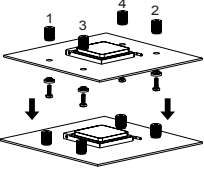
<p>步驟一：</p> 	<p>步驟二：</p> 
<p>步驟一： 先將風扇線扣裝置於散熱器本體，再將四個黑色砂膠管放入鱗片的四個凹痕。</p>	<p>步驟二： 依照您的處理器類型選擇對應於背板的孔位，將四根 M3L10 螺絲穿過背板及塑膠絕緣片後套上 AMD 墊圈 (大)。</p>
<p>步驟三：</p> 	
<p>步驟三： 注意！當您安裝於 939 主機板時，請先將 939 背蓋安裝於背板上。</p>	
<p>步驟四：</p> 	
<p>步驟四： 將背板安裝於主機板背面，再依序將穿過主機板的四個螺絲套上手轉螺絲。</p>	

步驟五

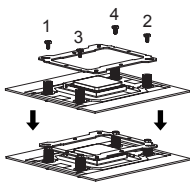

步驟五：
將固定框置於手轉螺絲上，再將 M3L6 螺絲穿過固定框，依序鎖入手轉螺絲上。

步驟六：

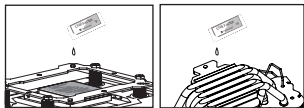

步驟六：
塗抹導熱膏於散熱器熱導管及中央處理器銅蓋上。

步驟七：

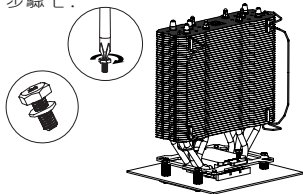

步驟七：
將散熱器置放於中央處理器上，再用 M3L7 螺絲穿過散熱器底部兩邊的螺絲孔位，鎖入固定框的對應孔位。

步驟八：

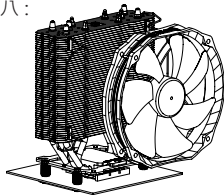

步驟八：
將風扇平貼於散熱器上，並將風扇線扣置風扇螺絲固定孔。

步驟九：

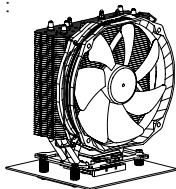

步驟九：
最後將風扇接頭插入主機板上的 CPU FAN 插槽，安裝完成。

Technical Spec

Heatsink Specifications:

Dimension: Length 140mm x Width 77mm x Height 161mm

Weight: 500g

Heatpipe: 6mm heatpipe*5 units

Fan Specification:

Dimension: L152mm x H140mm x W26.5mm

Weight: 160g

Fan speed: 300~1300RPM

Fan noise: 15~21dBA MAX

Airflow: 16.9~73.6CFM MAX

Connector: 4 Pin (PWM Fan connector)

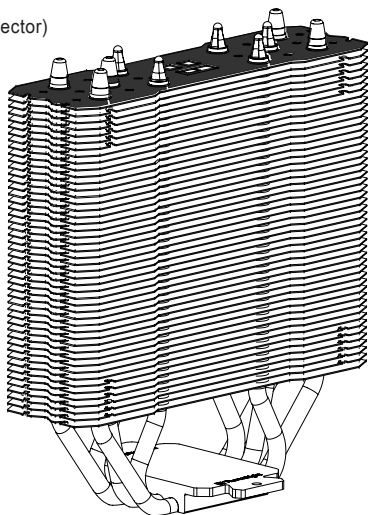

Technische Spezifikationen

Kühlkörper Spezifikationen:

Maße: Länge 140mm x Breite 77mm x Höhe 161mm

Gewicht: 500g

Heatpipe: 6mm Heatpipe*5 Stück

Lüfter Spezifikationen:

Maße: L152mm x H140mm x B26.5mm

Gewicht: 160g

Drehzahl: 300~1300 U/min

Lautstärke: 15~21dBA max.

Fördermenge: 28.7~125 m³/h max.

Anschluss: 4 Pin (PWM Lüfteranschluss)

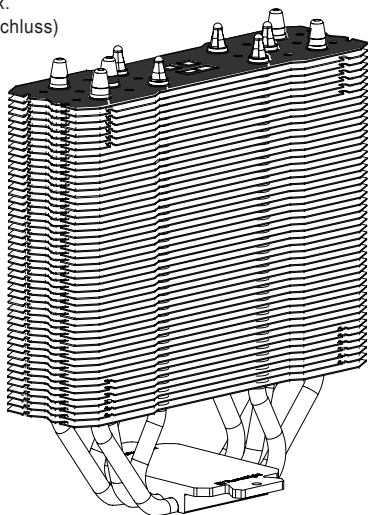

散熱器規格書

散熱器規格：

尺寸：長 140mm x 寬 77mm x 高 161mm

重量：650 克

熱導管：6mm 熱導管 *5 支

風扇規格：

尺寸：長 152mm x 高 140mm x 寬 26.5mm

重量：160 克

風扇轉速：300~1300RPM

風扇噪音：15~21dBA MAX

風量：16.9~73.6CFM MAX

接頭類型：4 Pin (PWM Fan connector)

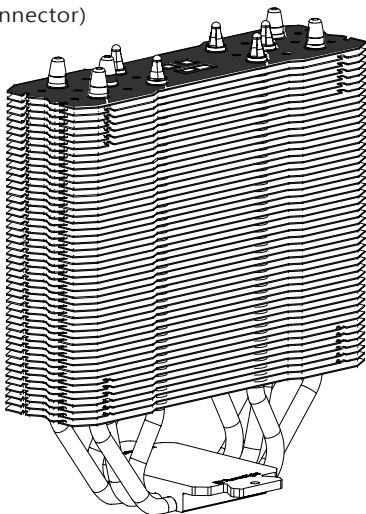

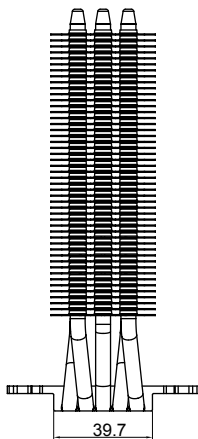
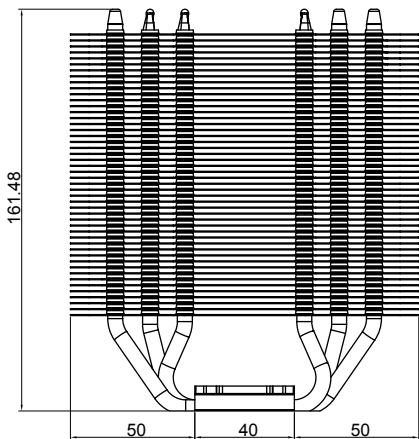
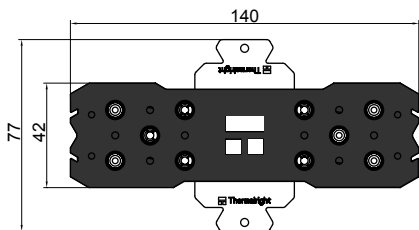

Einbau der LGA1151 Spacer

- 1.** Um den Spacer einzusetzen, installieren Sie bitte zuerst die CPU gemäß der Instruktionen von Intel
- 2.** Als nächstes wird der Spacer so eingesetzt, dass der Thermalright Schrifzug am Scharnier zu ruhen kommt und sie ihn lesen können
- 3.** Schließen Sie die Lastplatte und sichern Sie sie mit dem Riegel
- 4.** Sie sind fertig

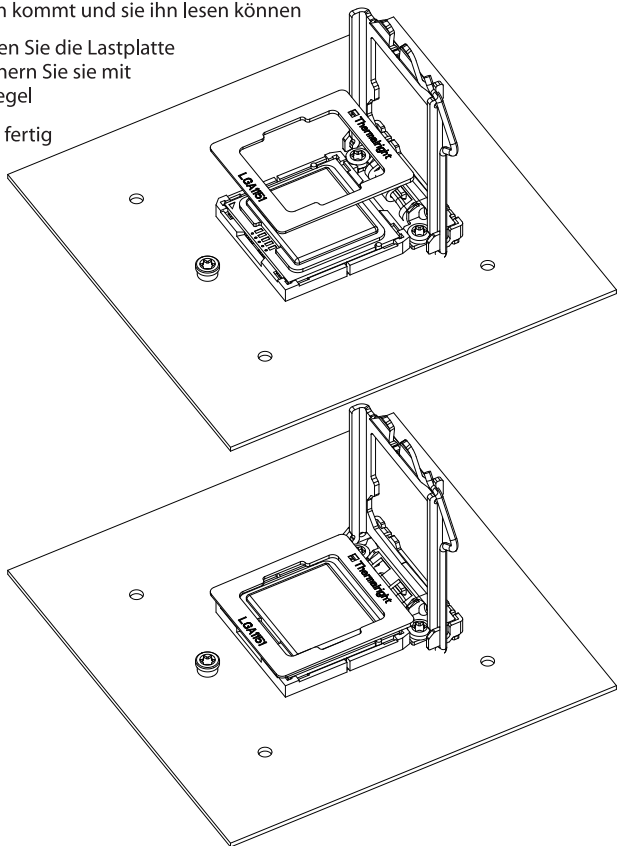

The Ultimate Cooling Solutions!

Thermalright Produkte werden in
Europa importiert und vertrieben
durch die:
PC-Cooling GmbH
Eichenallee 3
24589 Nortorf



Thermalright
www.thermalright.com

TEL: +886-2-2915-5005

FAX: +886-2-2915-5123

EMAIL: sales@thermalright.com