

Thermalright

HR-02

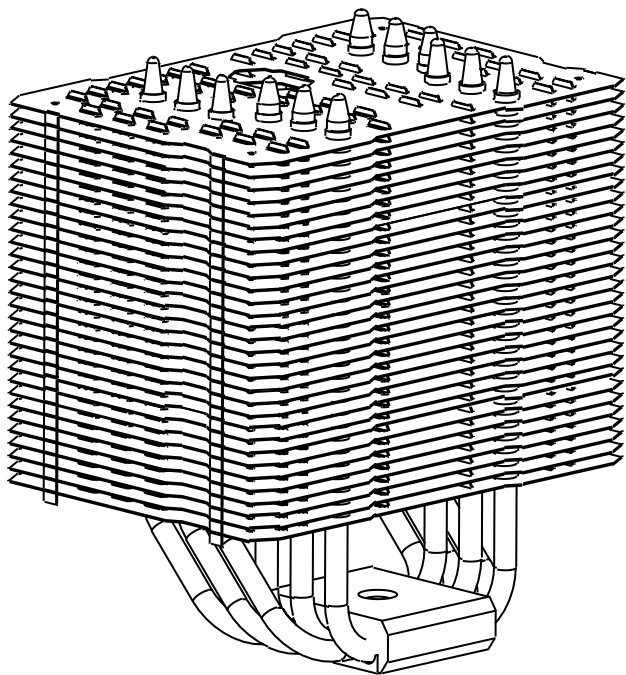

HR-02 Assembly package

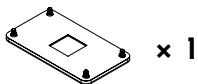
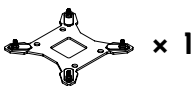
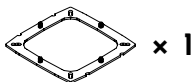
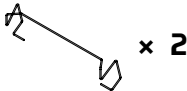





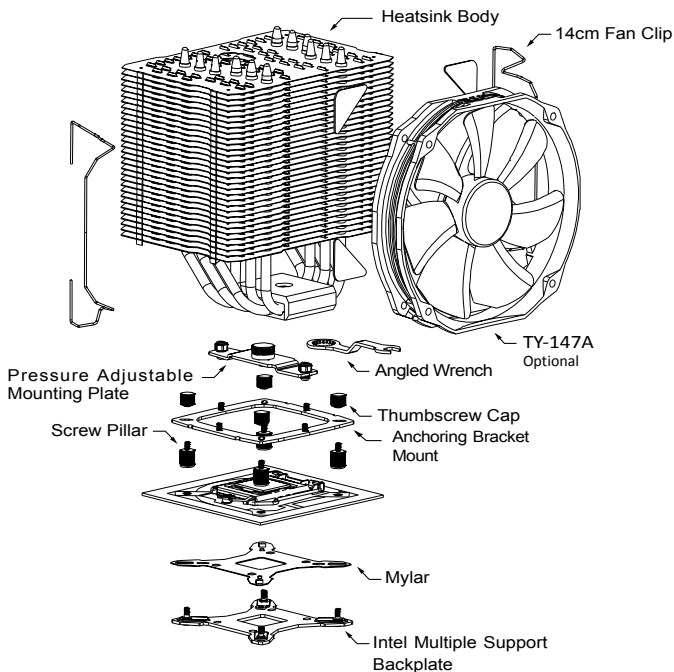

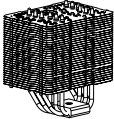
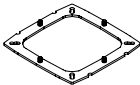
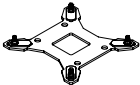
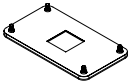

**4****4****8**

Exploded view

Important! Before proceeding with installation, please check for the most up-to-date instructions at www.thermalright.com

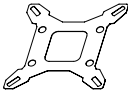
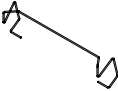

Component

		
		 
		 
		
1 Heatsink Body ×1	2 Anchoing Bracket Mount ×1	3 Intel Multiple Support Backplate ×1
4 AMD Backplate ×1	5 Pressure Adjustable Mounting Plate×1	6 Screw Pillar×4
7 LGA2011 Screw Pillar Type C×4	8 Thumbscrew Cap×4	9 Angled Wrench x1
10 Anti-Vibration Pad x 4	11 CF III ×1	12 Mylar Film x1
13 14cm Fan Clip x 2	14 12cm Fan Clip x 2	

Installation Instructions:

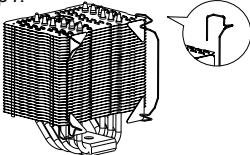
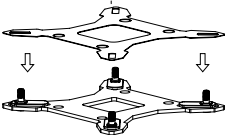
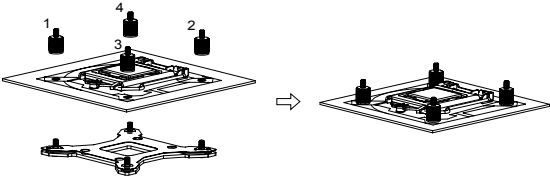
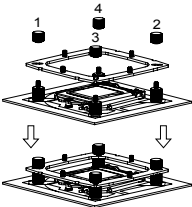
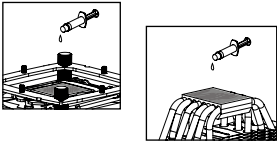
<p>Step1:</p> 	<p>Step2:</p> 
<p>Step 1 : Part Installation Take out HR-02 heat-sink from the color box. Apply Anti-Vibration Paddings to 4 corners on front side of the Heatsink Body. Pull both ends of the Fan clip (12 or 14 cm) and make them go through holes on the corners of the heat-sink. (As shown in the picture.) Repeat for the other fan clip. Leave both fan clips on the heat-sink body for fan installation later on. Do not remove them.</p>	<p>Step 2 : Backplate Installation Choose the correct Backplate according to your system (intel), and adjust the Screw Cylinders according to your platform (1150/1151/1155/1156/1366). See picture to the right. Place the included Mylar Film on the Backplate with four protruding screws going thru four holes on the Mylar Film.</p>
<p>Step3:</p> 	
<p>Step 3 : Backplate Installation (Cont'd) Pass the Backplate through mounting holes on the mainboard, then fit the Screw Pillars to the Backplate screws in a criss-cross pattern.</p>	
<p>Step4:</p> 	<p>Step5:</p> 
<p>Step 4 : Anchoring Mount Installation Place the Anchoring Bracket Mount on top of the four Screw Pillars. Tighten the 4 Screw Pillars with the Thumbscrew Caps in a criss-cross pattern.</p>	<p>Step 5 : Applying Thermal Paste Apply the Thermal Paste to the base of the Heatsink and the surface of the CPU evenly.</p>

Step6:

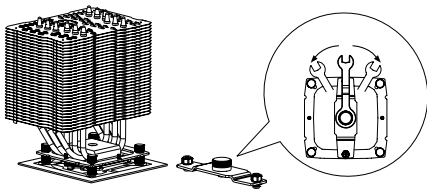

Step 6 : Mounting Plate
Make the Mounting plate to go through the heatsink.

Step7:

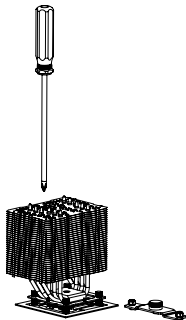

Step 7 : Place the heatsink on top of the cpu, and then tighten the hexagonal screws on both ends of the mouting plate. Use the included screw driver to fix the hexagonal screw underneath the heatsink.

Step8:

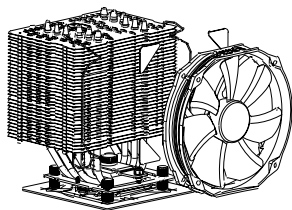

Step 8 : Place the included TY-147A(optional) onto the Heatsink Body. And then secure it with the Fan Clips, by pulling the Fan Clips to place the four ends at the four holes on the TY-147A.

Step9:

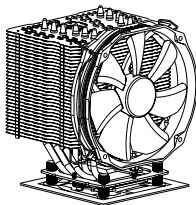

step 9 : Installation completed
Plug in the fan connector to the CPU PWM Fan socket on the motherboard. Installation complete

Exploded view

Important! Before proceeding with installation, please check for the most up-to-date instructions at www.thermalright.com

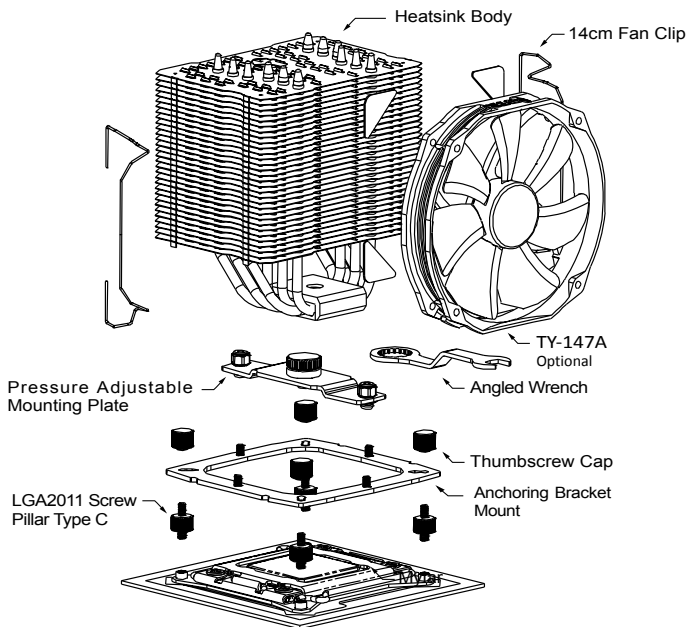

Installation Instructions:

Step1:

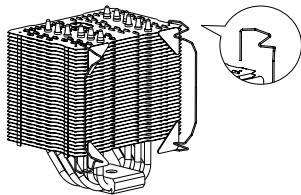

Step1 : Part Installation

Take out HR-02 heat-sink from the color box. Apply Anti-Vibration Paddings to 4 corners on front side of the Heatsink Body. Pull both ends of the Fan clip (12 or 14 cm) and make them go through holes on the corners of the heat-sink. (As shown in the picture.) Repeat for the other fan clip. Leave both fan clips on the heat-sink body for fan installation later on. Do not remove them.

Step2:

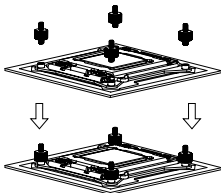

Step 2 : Screw Pillar Installation

Screw on the 4 LGA2011 Type C Screw Pillars into the heatsink studs on the Intel ILM Assembly Frame around the processor socket.

Step3:

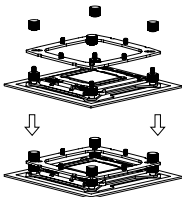

Step 3 : Anchoring Mount Installation

Place the Anchoring Bracket Mount on top of the 4 LGA2011 Type C Screw Pillars. Then tighten the 4 LGA2011 Type C Screw Pillars with the Thumbscrew Caps.

Step4:

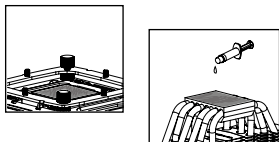

Step 4 : Applying Thermal Paste

Apply the Thermal Paste to the base of the Heatsink and the surface of the CPU evenly.

Step5:

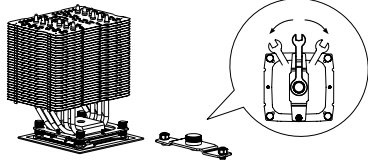

Step 5 : Mounting Plate
Make the Mounting plate to go through the heatsink.

Step6:

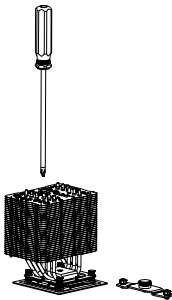

Step 6 : Place the heatsink on top of the cpu, and then tighten the hexagonal screws on both ends of the mounting plate.
Use the included screw driver to fix the hexagonal screw underneath the heatsink.

Step7:

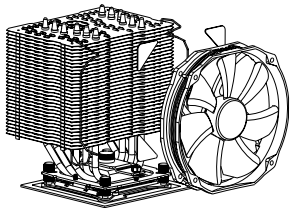

Step 7 : Fan Installation
Place the included TY-147A(optional) onto the Heatsink Body. And then secure it with the Fan Clips, by pulling the Fan Clips to place the four ends at the four holes on the TY-147A.

Step8:

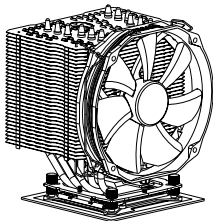

step 8 : Installation completed
Plug in the fan connector to the CPU PWM Fan socket on the motherboard. Installation complete

Exploded view

Important! Before proceeding with installation, please check for the most up-to-date instructions at www.thermalright.com

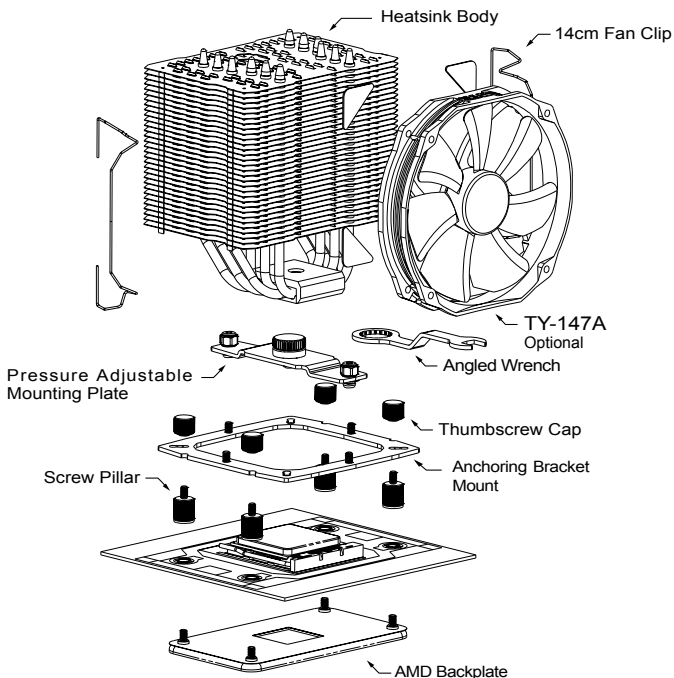

Installation Instructions:

Step1:

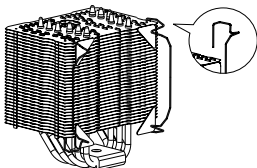

Step 1 : Part Installation

Take out HR-02 heat-sink from the color box. Apply Anti-Vibration Paddings to 4 corners on front side of the Heatsink Body. Pull both ends of the Fan clip (12 or 14 cm) and make them go through holes on the corners of the heat-sink. (As shown in the picture.) Repeat for the other fan clip. Leave both fan clips on the heat-sink body for fan installation later on. Do not remove them.

Step2:

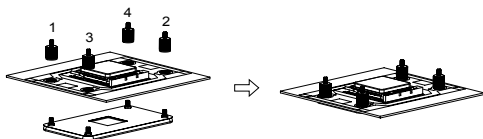

Step 2 : Backplate Cap

Pass the Backplate through mounting holes on the mainboard, then fit the Screw Pillars to the Backplate screws in a criss-cross pattern.

Step3:

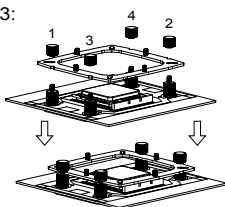

Step 3 : Anchoring Mount Installation

Place the Anchoring Mount on the Screw Nuts. Use the four M3L6 Screws to fix the Anchoring Mount on to the Screw Nuts in a criss-cross pattern.

Step4:

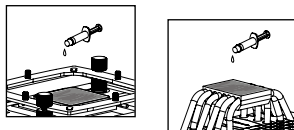

Step 4 : Applying Thermal Paste

Apply the Thermal Paste to the base of the Heatsink and the surface of the CPU evenly.

Step5:

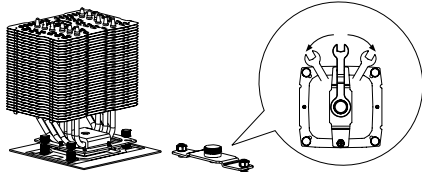

Step 5 : Mounting Plate
Make the Mounting plate to go through the heatsink.

Step6:

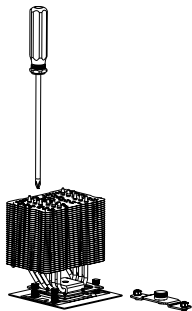

Step 6 : Place the heatsink on top of the cpu, and then tighten the hexagonal screws on both ends of the mounting plate. Use the included screw driver to fix the hexagonal screw underneath the heatsink.

Step7:

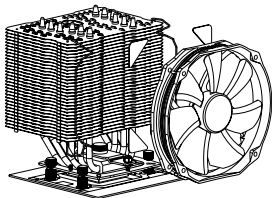

Step 7 : Fan Installation
Place the included TY-147A(optional) onto the Heatsink Body. And then secure it with the Fan Clips, by pulling the Fan Clips to place the four ends at the four holes on the TY-147A.

Step8:

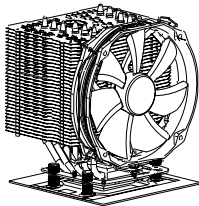

step 8 : Installation completed
Plug in the fan connector to the CPU PWM Fan socket on the motherboard. Installation complete

Technical Spec

Heatsink Specifications:

Dimension: Length 140mm x Width 102mm x Height 162mm

Weight: 850g

Heatpipe: 6mm heatpipe*6 units

Copper Base: C1100 Pure copper nickel plated

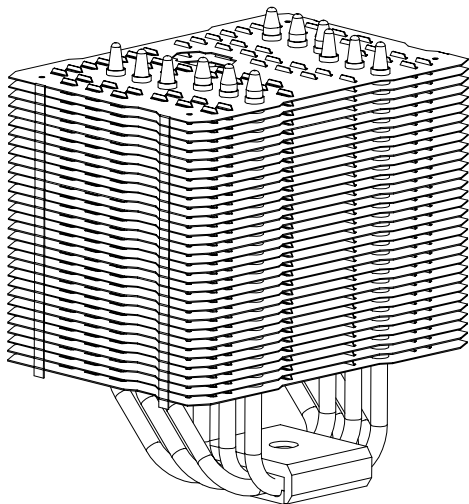

Thermalright HR-02

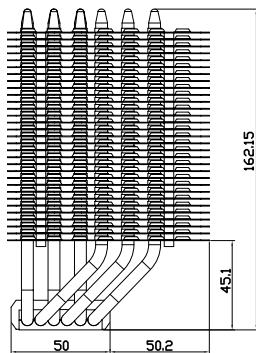
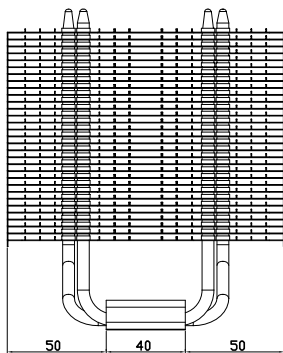
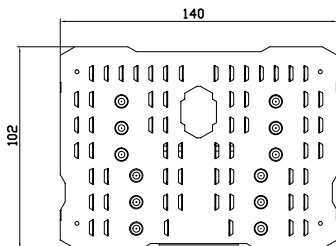

The Ultimate Cooling Solutions!



www.thermalright.com

TEL: +886-2-2915-5005

FAX: +886-2-2915-5123

EMAIL: sales@thermalright.com