

# Thermalright

## Thermalright True Spirit 120M

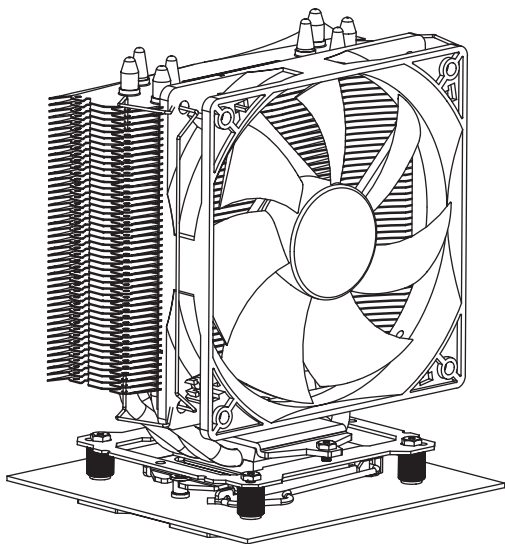



# Thermalright True Spirit 120M

## Assembly package

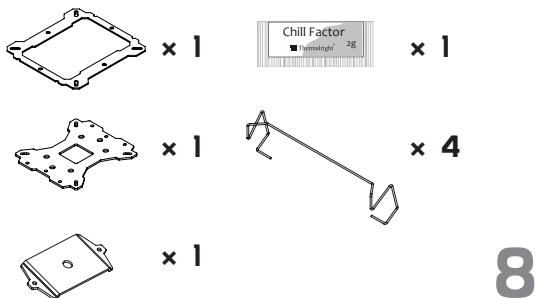
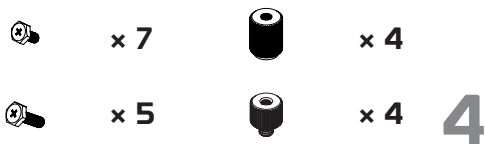
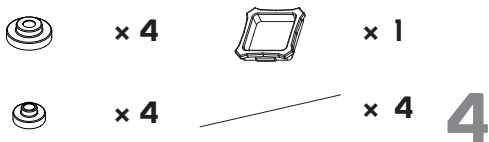





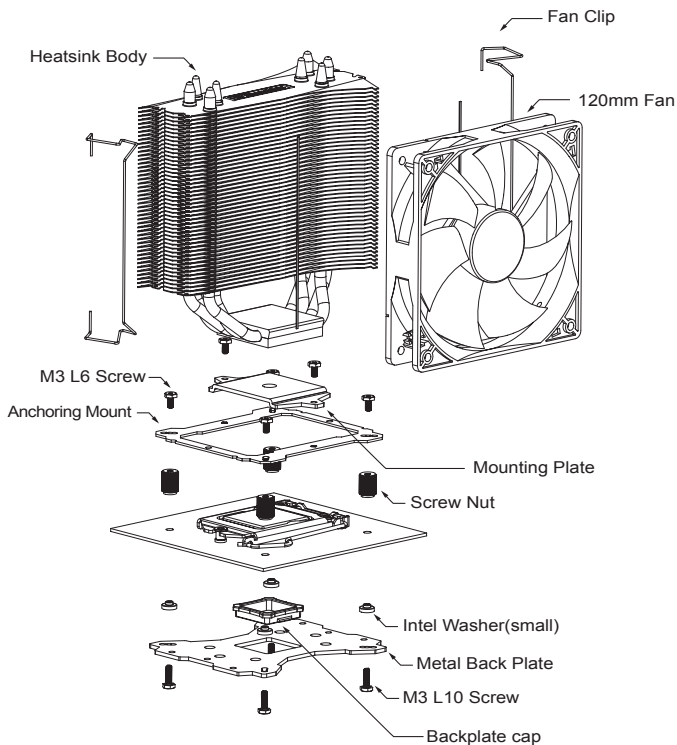



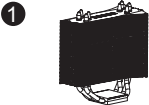
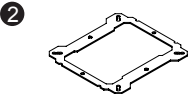
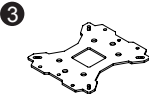
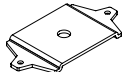

## Exploded view

**Important!** Before proceeding with installation, please check for the most up-to-date instructions at [www.thermalright.com](http://www.thermalright.com)

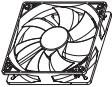

## Component

		
		
		
		
		
		
<b>1</b> Heatsink Body ×1	<b>2</b> Anchoring Mount ×1	<b>3</b> Metal Back Plate ×1
<b>4</b> Mounting Plate ×1	<b>5</b> Screw Nut ×4	<b>6</b> LGA2011 Type B Screw Pillars ×4
<b>7</b> M3 L10 Screw ×5	<b>8</b> M3 L6 Screw ×7	<b>9</b> Intel Washer (small) ×4
<b>10</b> AMD Washer (big) ×4	<b>11</b> Backplate cap ×1	<b>12</b> Thermal paste ×1
<b>13</b> 120mm Fan×1	<b>14</b> Fan Clip ×4	<b>15</b> Anti Vibration Strips ×4

# Installation Instructions:

## Step 1:

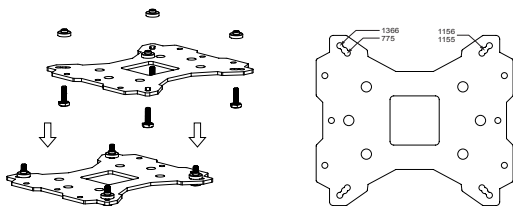

### Step 1 : Backplate Installation

Choose the platform (775/1155/1156/1366) you are in use. Make four M3L10 Screws go through the Metal Back Plate from bottom towards top. And then place the Metal Back Plate on the table. Put the four Washers (for Intel) around the Screw Cylinders.

## Step 2:

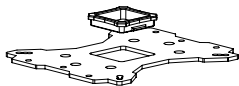

### Step 2 : backplate cap

Note: When installing on a 775 platform, please first insert the Back Plate Cap into the opening on the Back plate. Make sure you have the Cap facing downwards. (Only for 775).

## Step 3:

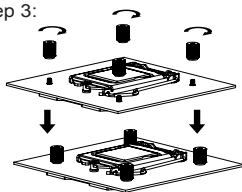

Step 3 : Place the motherboard on top of the Back Plate. See the four Screw Cylinders go through the four holes around the processor socket. Cap the four Screw Cylinders with the four Screw Nuts. Make sure the side with a washer is facing the Back Plate.

## Step 4:

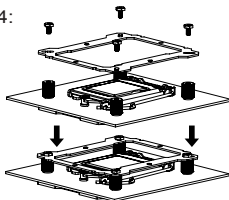

Step 4 : Place the Anchoring Mount on the Screw Nuts. Use the four M3L6 Screws to fix the Anchoring Mount on to the Screw Nuts.

## Step 5:

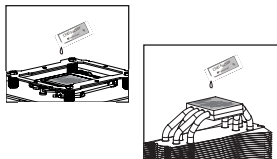

Step 5 : Applying Thermal Paste  
Apply the Thermal Paste to the base of the Heatsink and the surface of the CPU evenly.

### Step 6:

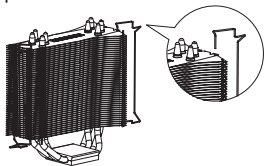

#### Step 6 : Fan Clip Installation

Pass each end of the Fan Clips through the mounting holes on the cooler body. Then stick one Anti Vibration Strip on each side of the cooler.

### Step 7:

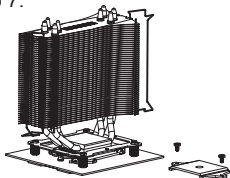

#### Step 7 : Mounting Plate

Installation Place the Heatsink Body on top of the CPU. Make Mounting Plate go through the Heatsink Body. And then use the two M3L6 screws to secure the Mounting Plate.

### Step 8:

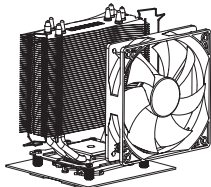

#### Step 8 : Fan Installation

Place the included 120mm Fan onto the Heatsink Body. And then secure it with the 120mm Fan Clips, by pulling the Fan Clips to place the four ends at the four holes on the 120mm Fan.

### Step 9:

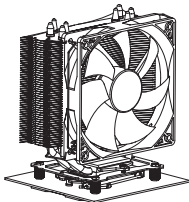

#### Step 9 : Installation completed

Plug in the fan connector to the CPU PWM Fan socket on the motherboard. Installation complete.





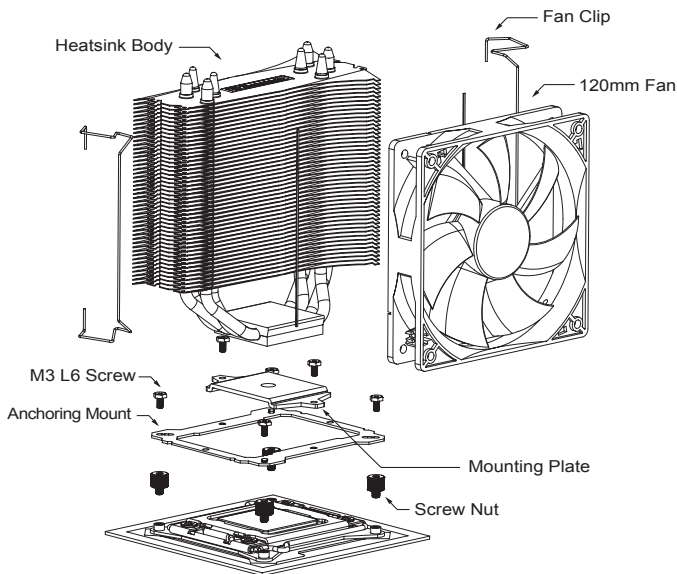





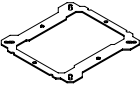

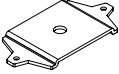

## Exploded view

**Important!** Before proceeding with installation, please check for the most up-to-date instructions at [www.thermalright.com](http://www.thermalright.com)





## Component

				
				
				
				
<b>1</b> Heatsink Body ×1	<b>2</b> Anchoring Mount ×1	<b>3</b> Metal Back Plate ×1		
<b>4</b> Mounting Plate ×1	<b>5</b> Screw Nut ×4	<b>6</b> LGA2011 Type B Screw Pillars ×4		
<b>7</b> M3 L10 Screw ×5	<b>8</b> M3 L6 Screw ×7	<b>9</b> Intel Washer (small) ×4		
<b>10</b> AMD Washer (big) ×4	<b>11</b> Backplate cap ×1	<b>12</b> Thermal paste ×1		
<b>13</b> 120mm Fan ×1	<b>14</b> Fan Clip ×4	<b>15</b> Anti Vibration Strips ×4		

# Installation Instructions:

## Step 1:

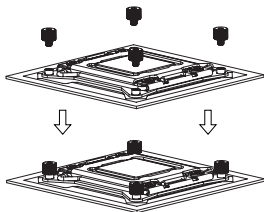

### Step 1 : Screw Pillar Installation

Screw on the four LGA2011 Type B Screw Pillars into the Heatsink studs on the ILM Assembly Frame around the processor socket.

## Step 2:

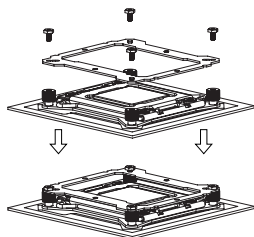

### Step 2 : Anchoring Mount Installation

Place the Anchoring Mount onto the four LGA2011 Type B Screw Pillars, secure it by tightening it with 4 M3L6 Screws.

## Step 3:

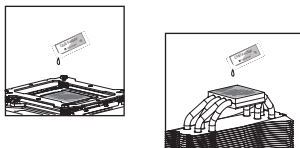

### Step 3 : Applying Thermal Paste

Apply the Thermal Paste to the base of the Heatsink and the surface of the CPU evenly.

#### Step 4:

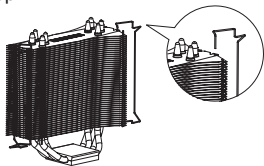

#### Step 4 : Fan Clip Installation

Pass each end of the Fan Clips through the mounting holes on the cooler body. Then stick one Anti Vibration Strip on each side of the cooler.

#### Step 5:

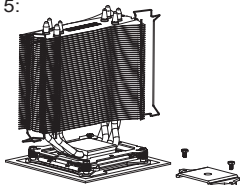

#### Step 5 : Mounting Plate

Installation Place the Heatsink Body on top of the CPU. Make Mounting Plate go through the Heatsink Body. And then use the two M3L6 screws to secure the Mounting Plate.

#### Step 6:

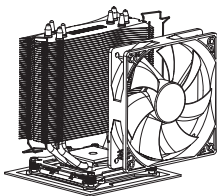

#### Step 6 : Fan Installation

Place the included 120mm Fan onto the Heatsink Body. And then secure it with the 120mm Fan Clips, by pulling the Fan Clips to place the four ends at the four holes on the 120mm Fan.

#### Step 7:

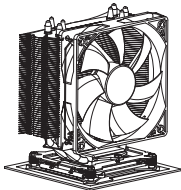

#### Step 7 : Installation completed







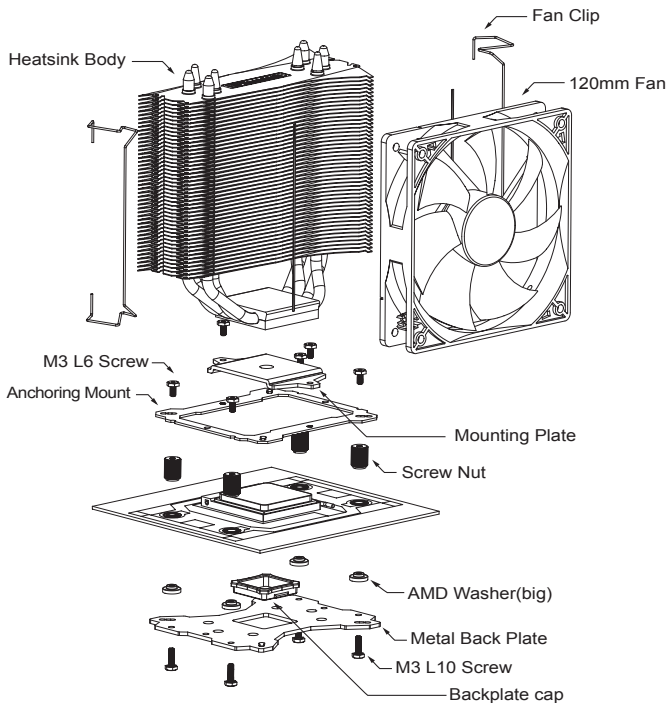

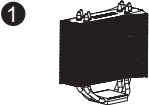
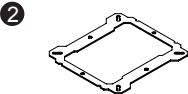
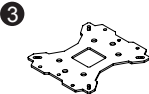
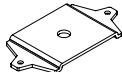

Plug in the fan connector to the CPU PWM Fan socket on the motherboard. Installation complete.

## Exploded view

**Important!** Before proceeding with installation, please check for the most up-to-date instructions at [www.thermalright.com](http://www.thermalright.com)

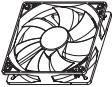

## Component

				
				
				
				
<b>1</b> Heatsink Body ×1	<b>2</b> Anchoring Mount ×1	<b>3</b> Metal Back Plate ×1		
<b>4</b> Mounting Plate ×1	<b>5</b> Screw Nut ×4	<b>6</b> LGA2011 Type B Screw Pillars ×4		
<b>7</b> M3 L10 Screw ×5	<b>8</b> M3 L6 Screw ×7	<b>9</b> Intel Washer (small) ×4		
<b>10</b> AMD Washer (big) ×4	<b>11</b> Backplate cap ×1	<b>12</b> Thermal paste ×1		
<b>13</b> 120mm Fan ×1	<b>14</b> Fan Clip ×4	<b>15</b> Anti Vibration Strips ×4		

# Installation Instructions:

## Step 1:

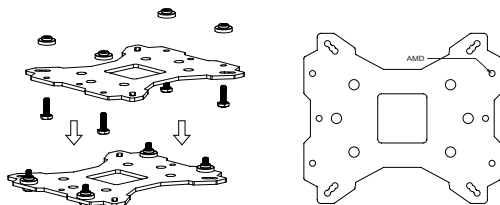

### Step 1 : Backplate Installation

Choose the platform (AMD) you are in use. Make four M3L10 Screws go through the Metal Back Plate from bottom towards top. And then place the Metal Back Plate on the table. Put the four Washers (for AMD) around the Screw Cylinders.

## Step 2:

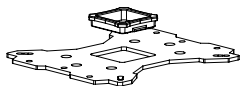

### Step 2 : backplate cap

Note: When installing on a 939 platform, please first insert the Back Plate Cap into the opening on the Back plate. Make sure you have the Cap facing downwards. (Only for 939).

## Step 3:

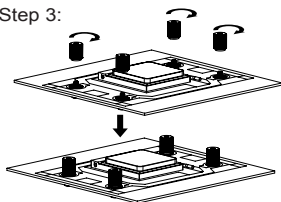

Step3 : Place the motherboard on top of the Back Plate. See the four Screw Cylinders go through the four holes around the processor socket. Cap the four Screw Cylinders with the four Screw Nuts. Make sure the side with a washer is facing the Back Plate.

## Step 4:

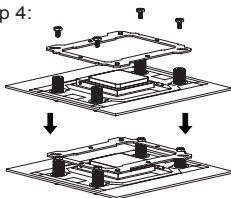

### Step 4 : Anchoring Mount Installation

Place the Anchoring Mount on the Screw Nuts. Use the four M3L6 Screws to fix the Anchoring Mount on to the Screw Nuts.

## Step 5:

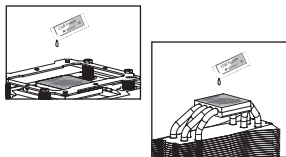

### Step 5 : Applying Thermal Paste

Apply the Thermal Paste to the base of the Heatsink and the surface of the CPU evenly.

### Step 6:

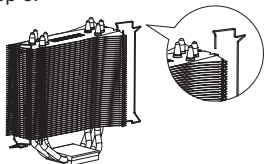

#### Step 6 : Fan Clip Installation

Pass each end of the Fan Clips through the mounting holes on the cooler body. Then stick one Anti Vibration Strip on each side of the cooler.

### Step 7:

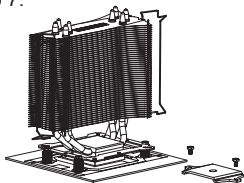

#### Step 7 : Mounting Plate Installation

Installation Place the Heatsink Body on top of the CPU. Make Mounting Plate go through the Heatsink Body. And then use the two M3L6 screws to secure the Mounting Plate.

### Step 8:

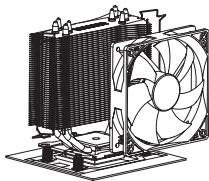

#### Step 8 : Fan Installation

Place the included 120mm Fan onto the Heatsink Body. And then secure it with the 120mm Fan Clips, by pulling the Fan Clips to place the four ends at the four holes on the 120mm Fan.

### Step 9:

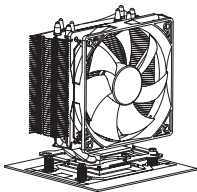

#### Step 9 : Installation completed

Plug in the fan connector to the CPU PWM Fan socket on the motherboard. Installation complete.





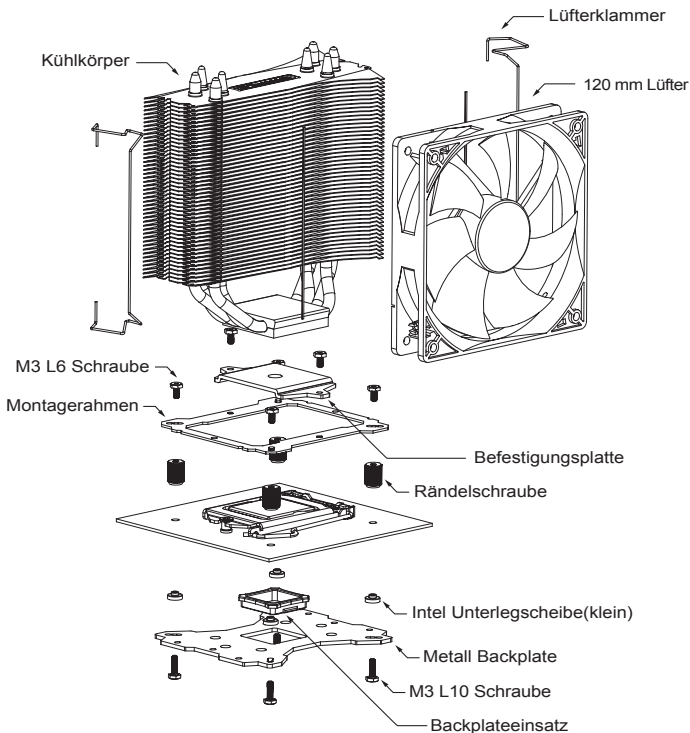





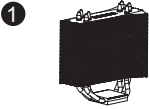
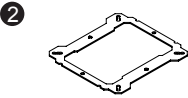
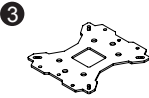

## Explosionszeichnung

**Wichtig!** Bitte prüfen Sie vor der Montage, ob für Ihren Kühler aktualisierte Montagehinweise auf der Webseite [www.thermalright.com](http://www.thermalright.com) verfügbar sind.





## Komponenten

				
				
				
				
<b>1</b> Kühlkörper ×1	<b>2</b> Montagerahmen ×1	<b>3</b> Metall Backplate ×1		
<b>4</b> Befestigungsplatte ×1	<b>5</b> Rändelschraube ×4	<b>6</b> LGA2011 Type B Adapterschraube ×4		
<b>7</b> M3 L10 Schraube ×5	<b>8</b> M3 L6 Schraube ×7	<b>9</b> Intel Unterlegscheibe (klein) ×4		
<b>10</b> AMD Unterlegscheibe (groß) ×4	<b>11</b> Backplateeinsatz ×1	<b>12</b> Wärmeleitpaste ×1		
<b>13</b> 120 mm Lüfter ×1	<b>14</b> Lüfterklammer ×4	<b>15</b> Anti-Vibrationsstreifen ×4		

# Installationsanleitung:

## Schritt 1:

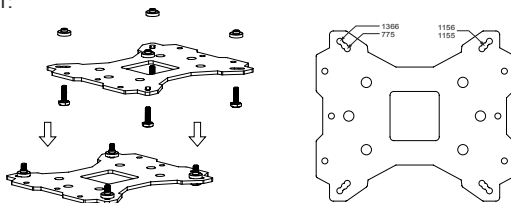

Wählen Sie die Plattform (775/1156/1155/1366), die Sie verwenden möchten. Führen Sie vier M3L10 Adapterschrauben von unten nach oben durch die Metall Backplate. Legen Sie die Metall Backplate auf den Tisch. Legen Sie die vier Unterlegscheiben (für Intel) auf die Schraubenzylinder.

## Schritt 2:

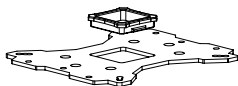

Beachten Sie bitte: Sofern Sie ein 775 System benutzen, setzen Sie bitte zuerst den Backplateeinsatz in die quadratische Öffnung der Backplate ein und achten Sie darauf, dass diese nach unten weist (nur für Sockel LGA775 erforderlich).

## Schritt 3:

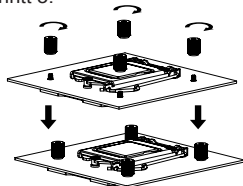

Platzieren Sie nun das Motherboard auf die Backplate. Achten Sie darauf, dass die vier Schraubenzylinder durch die vier Montagelöcher am Prozessorsockel gehen. Schrauben Sie die vier Rändelschrauben auf die vier Schraubenzylinder. Stellen Sie dabei sicher, dass die Seite mit den Unterlegscheiben zur Backplate gerichtet ist.

## Schritt 4:

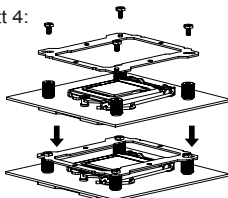

Platzieren Sie den Montagerahmen auf die Rändelschrauben. Verwenden Sie die vier M3L16 Schrauben, um den Montagerahmen auf den Rändelschrauben zu fixieren.

## Schritt 5:

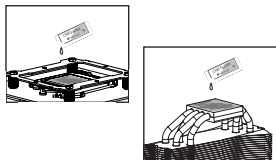

Tragen Sie eine hauchdünne Schicht Wärmeleitpaste plan auf der Oberseite der CPU und auf der Unterseite des Kühlers auf.

### Schritt 6:

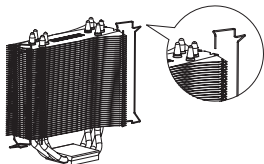

Führen Sie die Enden der Lüfterklammer in die entsprechenden Befestigungslöcher in die Ober- und Unterseite des Kühlkörpers. Anschließend kleben Sie einen Anti-Vibrationsstreifen an beiden Seiten (links und rechts) der Lüfterauflagefläche.

### Schritt 7:

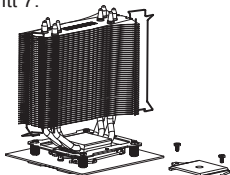

Platzieren Sie nun den Kühlkörper auf die CPU. Führen Sie anschließend die Befestigungsplatte durch den Kühlkörper und benutzen die beiden M3L6 Schrauben, um die Befestigungsplatte zu befestigen.

### Schritt 8:

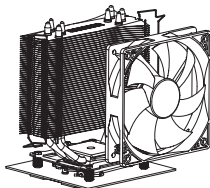

Platzieren Sie den mitgelieferten 120 mm Lüfter an den Kühlkörper und sichern ihn mit den Lüfterklammern. Hierzu ziehen Sie an den am Kühlkörper befestigten Klammern, um die Ecken in die Befestigungslöcher im Lüfterrahmen des Lüfters einrasten zu lassen.

### Schritt 9:

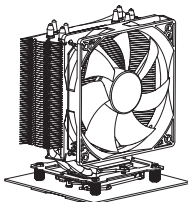







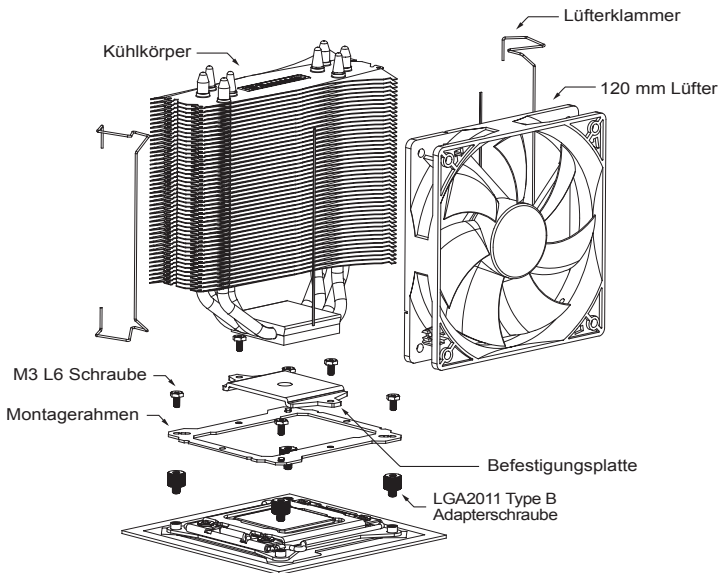



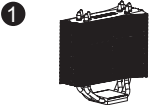
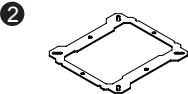
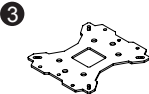

Schließen Sie den Lüfterstecker an den CPU PWM Lüfteranschluss auf dem Mainboard an. Bitte prüfen Sie die ordnungsgemäße Funktion vor der Inbetriebnahme Ihres PC. Die Installation ist abgeschlossen.

## Explosionszeichnung

**Wichtig!** Bitte prüfen Sie vor der Montage, ob für Ihren Kühler aktualisierte Montagehinweise auf der Webseite [www.thermalright.com](http://www.thermalright.com) verfügbar sind.



## Komponenten

		
		
		
		
		
		
<b>1</b> Kühlkörper ×1	<b>2</b> Montagerahmen ×1	<b>3</b> Metall Backplate ×1
<b>4</b> Befestigungsplatte ×1	<b>5</b> Rändelschraube ×4	<b>6</b> LGA2011 Type B Adapterschraube ×4
<b>7</b> M3 L10 Schraube ×5	<b>8</b> M3 L6 Schraube ×7	<b>9</b> Intel Unterlegscheibe (klein) ×4
<b>10</b> AMD Unterlegscheibe (groß) ×4	<b>11</b> Backplateeinsatz ×1	<b>12</b> Wärmeleitpaste ×1
<b>13</b> 120 mm Lüfter ×1	<b>14</b> Lüfterklammer ×4	<b>15</b> Anti-Vibrationsstreifen ×4

# Installationsanleitung:

## Schritt 1:

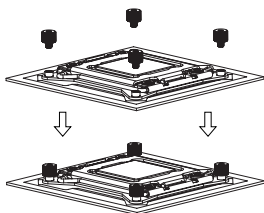

Schrauben Sie die vier LGA2011 Type B Adapterschrauben in die Gewinde des Montagerahmens, der sich um den Prozessorsockel befindet.

## Schritt 2:

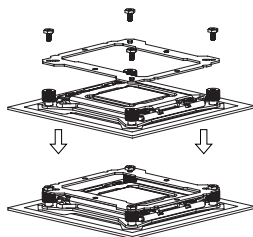

Platzieren Sie den Befestigungsrahmen auf die LGA2011 Type B Adapterschrauben und fixieren ihn mit vier M3L6 Schrauben.

## Schritt 3:

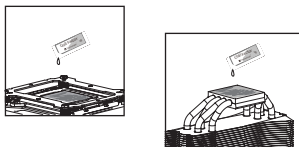

Tragen Sie eine hauchdünne Schicht Wärmeleitpaste auf der Oberfläche der CPU und auf der Unterseite des Kühlers auf.

#### Schritt 4:

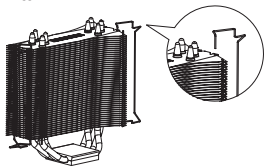

#### Schritt 5:

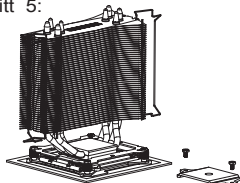

Führen Sie die Enden der Lüfterklammer in die entsprechenden Befestigungslöcher an der Ober- und Unterseite des Kühlkörpers. Anschließend kleben Sie einen Anti-Vibrationsstreifen an beiden Seiten (links und rechts) der Lüfterauflagefläche.

Platzieren Sie nun den Kühlkörper auf die CPU. Führen Sie anschließend die Befestigungsplatte durch den Kühlkörper und benutzen die beiden M3L6 Schrauben, um die Befestigungsplatte zu befestigen.

#### Schritt 6:

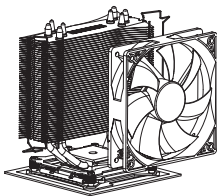

Platzieren Sie den mitgelieferten 120 mm Lüfter an den Kühlkörper und sichern ihn mit den Lüfterklammern. Hierzu ziehen Sie an den am Kühlkörper befestigten Klammern, um die Ecken in die Befestigungslöcher im Lüfterrahmen des Lüfters einrasten zu lassen.

#### Schritt 7:

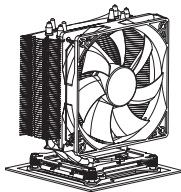

Schließen Sie den Lüfterstecker an den CPU PWM Lüfteranschluss auf dem Mainboard an. Bitte prüfen Sie die ordnungsgemäße Funktion vor der Inbetriebnahme Ihres PC. Die Installation ist abgeschlossen.





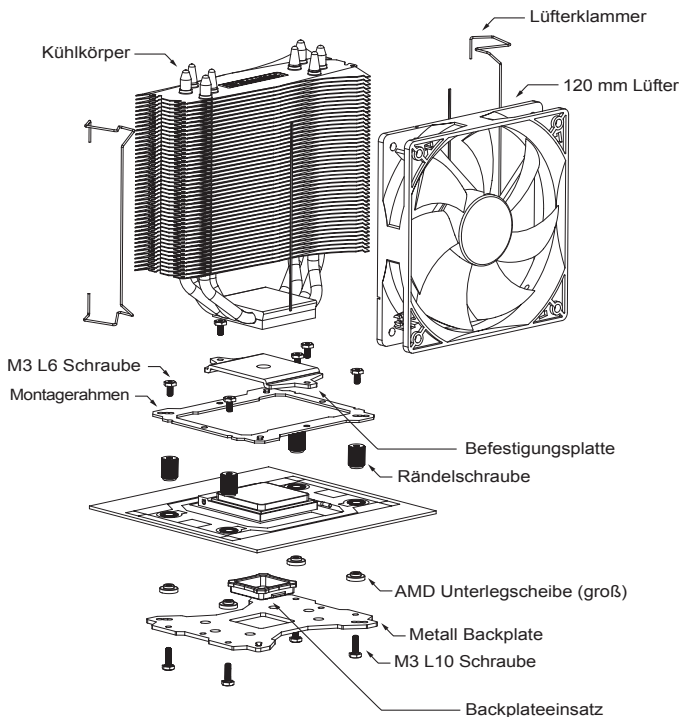



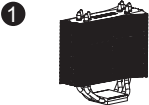
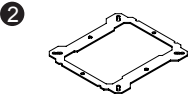
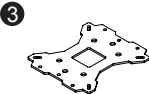
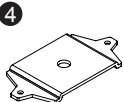

## Explosionszeichnung

**Wichtig!** Bitte prüfen Sie vor der Montage, ob für Ihren Kühler aktualisierte Montagehinweise auf der Webseite [www.thermalright.com](http://www.thermalright.com) vorhanden sind.



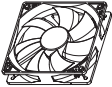

## Komponenten

				
				
				
				
<b>1</b> Kühlkörper ×1	<b>2</b> Montagerahmen ×1	<b>3</b> Multi Plattform Backplate ×1		
<b>4</b> Befestigungsplatte ×1	<b>5</b> Rändelschraube ×4	<b>6</b> LGA2011 Type B Adapterschraube ×4		
<b>7</b> M3 L10 Schraube ×5	<b>8</b> M3 L6 Schraube ×7	<b>9</b> Intel Unterlegscheibe (klein) ×4		
<b>10</b> AMD Unterlegscheibe (groß) ×4	<b>11</b> Backplateeinsatz ×1	<b>12</b> Wärmeleitpaste ×1		
<b>13</b> 120 mm Lüfter ×1	<b>14</b> Lüfterklammer ×4	<b>15</b> Anti-Vibrationsstreifen ×4		

# Installationsanleitung:

## Schritt 1:

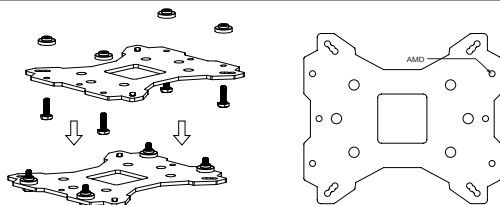

Achten Sie auf die für AMD Sockel vorgesehene Bohrungen in der Multi Plattform Backplate. Führen Sie die vier M3L10 Schrauben jeweils von unten durch diese Bohrungen und legen dann die Backplate auf den Tisch. Legen Sie die vier Unterlegscheiben (für AMD) über die hervorstehenden Gewinde.

## Schritt 2:

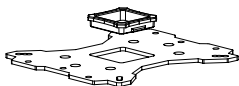

Beachten Sie: Bei Verwendung einer AMD Sockel 939 Plattform setzen Sie zuerst den Backplate Aufsatz in die quadratische Öffnung der Backplate ein. Gehen Sie sicher, dass der Aufsatz nach unten zeigt.

## Schritt 3:

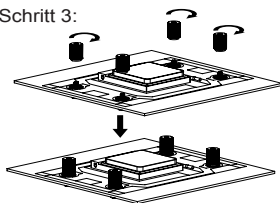

Platzieren Sie das Mainboard von oben auf die Backplate, so dass die hervorstehenden Schraubengewinde durch die Löcher um den Prozessorsockel gehen. Schrauben Sie die Rändelschrauben auf die vier Schraubengewinde. Achten Sie dabei darauf, dass die Seite mit der Unterlegscheibe zur Backplate zeigt.

## Schritt 4:

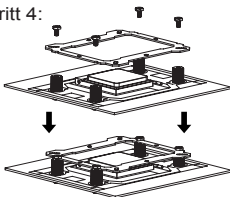

Setzen Sie den Montagerahmen auf die Rändelschrauben. Verwenden die vier M3L6 Schrauben, um den Montagerahmen auf den Rändelschrauben zu befestigen.

## Schritt 5:

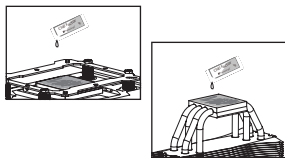

Tragen Sie eine hauchdünne Schicht Wärmeleitpaste auf der Oberfläche der CPU und auf der Unterseite des Kühlers auf.

### Schritt 6:

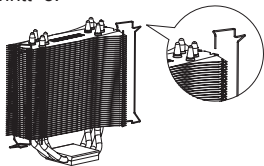

Führen Sie die Enden der Lüfterklammer in die entsprechenden Befestigungslöcher an der Ober- und Unterseite des Kühlkörpers. Anschließend kleben Sie einen Anti-Vibrationsstreifen an beiden Seiten (links und rechts) der Lüfterauflagefläche.

### Schritt 7:

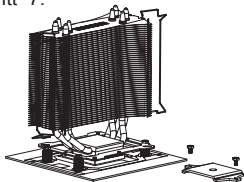

Platzieren Sie nun den Kühlkörper auf die CPU. Führen Sie anschließend die Befestigungsplatte durch den Kühlkörper und benutzen die beiden M3L6 Schrauben, um die Befestigungsplatte zu befestigen.

### Schritt 8:

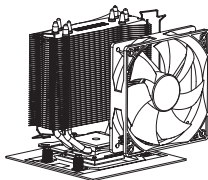

Platzieren Sie den mitgelieferten 120 mm Lüfter an den Kühlkörper und sichern ihn mit den Lüfterklammern. Hierzu ziehen Sie an den am Kühlkörper befestigten Klammern, um die Ecken in die Befestigungslöchern im Lüfterrahmen des Lüfters einrasten zu lassen.

### Schritt 9:

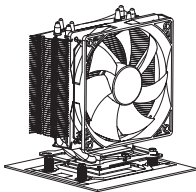

Schließen Sie den Lüfterstecker an den CPU PWM Lüfteranschluss auf dem Mainboard an. Bitte prüfen Sie die ordnungsgemäße Funktion vor der Inbetriebnahme Ihres PC. Die Installation ist abgeschlossen.

# Thermalright True Spirit 120M

## Technical Spec

### Heatsink Specifications:

Dimension: Length 132mm x Width 57.72mm x Height 145.15mm

Weight: 784g (including fan and mounting brackets)

Heatpipe: 6mm heatpipe\*4 units

Copper Base: C1100 Pure copper nickel plated

### Fan Specification:

Dimension: L120mm x H120mm x W25mm

Weight: 95g

Fan speed: 700~1500RPM (PWM controlled)

Fan noise: 28.5dBA MAX (Test distance 1.0M)

Airflow: 53.3CFM MAX

Connector: 4 Pin (PWM Fan connector)

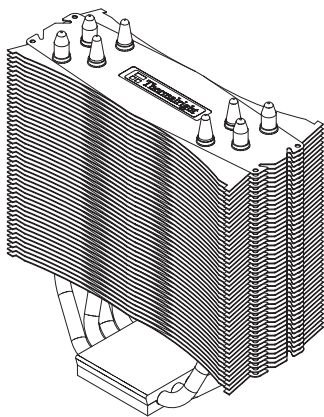

# Thermalright True Spirit 120M

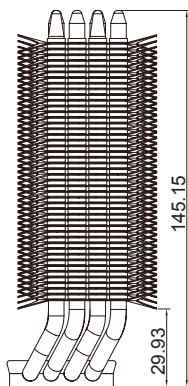
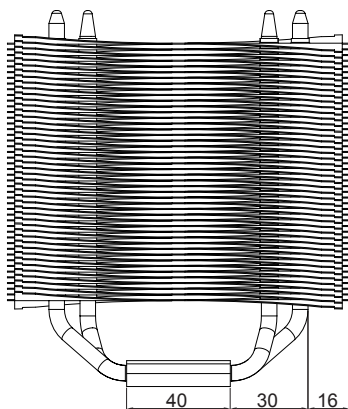
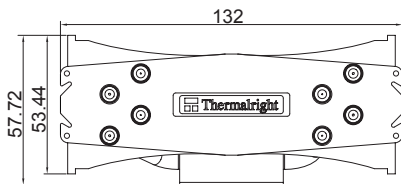

# Thermalright True Spirit I20M

## Thermalright True Spirit Series

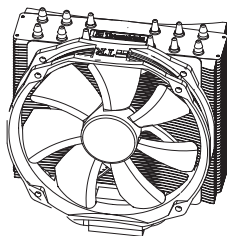

True Spirit 140

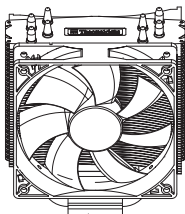

True Spirit 120

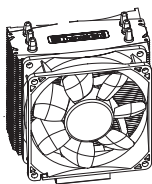

True Spirit 90

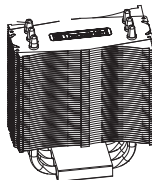
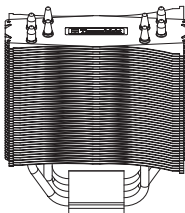
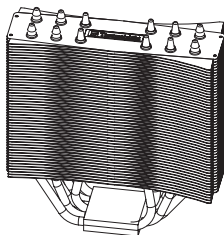



**The Ultimate Cooling Solutions!**



**Thermalright**

**[www.thermalright.com](http://www.thermalright.com)**

**TEL: +886-2-8663-6630**

**FAX: +886-2-8663-6645**

**EMAIL: [sales@thermalright.com](mailto:sales@thermalright.com)**